



**Strata CIX and CTX
IPT/DKT Telephone
User Guide**

Important! *Toshiba Telecommunication Systems Division sells its products through Authorized Dealers. Our Dealers are certified in Sales and Technical Training for Toshiba products, and focus on providing the best possible customer experience. Dealer services include: network assessments, product recommendations, installations, and ongoing technical and sales support. Before making any changes or updates to their Toshiba Telecom product (hardware or software), Toshiba advises Businesses to contact their System's installing Dealer or an Authorized Toshiba Dealer in their area.*

To locate a Toshiba Telecom dealer, visit: www.telecom.toshiba.com

Publication Information

Toshiba America Information Systems, Inc., Telecommunication Systems Division, reserves the right, without prior notice, to revise this information publication for any reason, including, but not limited to, utilization of new advances in the state of technical arts or to simply change the design of this document.

Further, Toshiba America Information Systems, Inc., Telecommunication Systems Division, also reserves the right, without prior notice, to make such changes in equipment design or components as engineering or manufacturing methods may warrant.

CIX-UG-DKIPT-VE-E

Version E.1, August 2007

© Copyright 2006-2007 Toshiba America Information Systems, Inc. Telecommunication Systems Division

All rights reserved. No part of this manual, covered by the copyrights hereon, may be reproduced in any form or by any means—graphic, electronic, or mechanical, including recording, taping, photocopying, or information retrieval systems—without express written permission of the publisher of this material.

Strata is a registered trademark of Toshiba Corporation. Strategy is a registered trademark of Toshiba America Information Systems, Inc.

Trademarks, registered trademarks, and service marks are the property of their respective owners.

CAUTION! Do not use cleansers that contain benzene, paint thinner, alcohol or other solvents on the telephone's rubber feet. The color of the rubber may transfer to the desk or mounting surface.

TOSHIBA AMERICA INFORMATION SYSTEMS, INC. (“TAIS”)

Telecommunication Systems Division License Agreement

IMPORTANT: THIS LICENSE AGREEMENT (“AGREEMENT”) IS A LEGAL AGREEMENT BETWEEN YOU (“YOU”) AND TAIS. CAREFULLY READ THIS LICENSE AGREEMENT. USE OF ANY SOFTWARE OR ANY RELATED INFORMATION (COLLECTIVELY, “SOFTWARE”) INSTALLED ON OR SHIPPED WITH A TAIS TELECOMMUNICATION SYSTEMS PRODUCT OR OTHERWISE MADE AVAILABLE TO YOU BY TAIS IN WHATEVER FORM OR MEDIA, WILL CONSTITUTE YOUR ACCEPTANCE OF THESE TERMS, UNLESS SEPARATE TERMS ARE PROVIDED BY THE SOFTWARE SUPPLIER. IF YOU DO NOT AGREE WITH THE TERMS OF THIS LICENSE AGREEMENT, DO NOT INSTALL, COPY OR USE THE SOFTWARE AND PROMPTLY RETURN IT TO THE LOCATION FROM WHICH YOU OBTAINED IT IN ACCORDANCE WITH APPLICABLE RETURN POLICIES. EXCEPT AS OTHERWISE AUTHORIZED IN WRITING BY TAIS, THIS SOFTWARE IS LICENSED FOR DISTRIBUTION THROUGH TAIS AUTHORIZED CHANNELS ONLY TO END-USERS PURSUANT TO THIS LICENSE AGREEMENT.

- 1. License Grant.** The Software is not sold; it is licensed upon payment of applicable charges. TAIS grants to you a personal, non-transferable and non-exclusive right to use the copy of the Software provided under this License Agreement. You agree you will not copy the Software except as necessary to use it on one TAIS system at a time at one location. Modifying, translating, renting, copying, distributing, printing, sublicensing, transferring or assigning all or part of the Software, or any rights granted hereunder, to any other persons and removing any proprietary notices, labels or marks from the Software is strictly prohibited except as permitted by applicable law; you agree violation of such restrictions will cause irreparable harm to TAIS and provide grounds for injunctive relief, without notice, against you or any other person in possession of the Software. You and any other person whose possession of the software violates this License Agreement shall promptly surrender possession of the Software to TAIS, upon demand. Furthermore, you hereby agree not to create derivative works based on the Software. TAIS reserves the right to terminate this license and to immediately repossess the software in the event that you or any other person violates this License Agreement. Execution of the Software for any additional capabilities require a valid run-time license.
- 2. Intellectual Property.** You acknowledge that no title to the intellectual property in the Software is transferred to you. You further acknowledge that title and full ownership rights to the Software will remain the exclusive property of TAIS and/or its suppliers, and you will not acquire any rights to the Software, except the license expressly set forth above. You will not remove or change any proprietary notices contained in or on the Software. The Software is protected under U.S. patent, copyright, trade secret, and/or other proprietary laws, as well as international treaties. Any transfer, use, or copying of the software in violation of the License Agreement constitutes copyright infringement. You are hereby on notice that any transfer, use, or copying of the Software in violation of this License Agreement constitutes a willful infringement of copyright.
- 3. No Reverse Engineering.** You agree that you will not attempt, and if you employ employees or engage contractors, you will use your best efforts to prevent your employees and contractors from attempting to reverse compile, reverse engineer, modify, translate or disassemble the Software in whole or in part. Any failure to comply with the above or any other terms and conditions contained herein will result in the automatic termination of this license and the reversion of the rights granted hereunder back to TAIS.
- 4. Limited Warranty.** THE SOFTWARE IS PROVIDED “AS IS” WITHOUT WARRANTY OF ANY KIND. TO THE MAXIMUM EXTENT PERMITTED BY APPLICABLE LAW, TAIS AND ITS SUPPLIERS DISCLAIM ALL WARRANTIES WITH REGARD TO THE SOFTWARE, EITHER EXPRESS OR IMPLIED, INCLUDING, BUT NOT LIMITED TO, THE WARRANTY OF NON-INFRINGEMENT OF THIRD PARTY RIGHTS, THE WARRANTY OF YEAR 2000 COMPLIANCE, AND THE IMPLIED WARRANTIES OF MERCHANTABILITY AND FITNESS FOR A PARTICULAR PURPOSE. THE ENTIRE RISK AS TO THE QUALITY AND PERFORMANCE OF THE SOFTWARE IS WITH YOU. NEITHER TAIS NOR ITS SUPPLIERS WARRANT THAT THE FUNCTIONS CONTAINED IN THE SOFTWARE WILL MEET YOUR REQUIREMENTS OR THAT THE OPERATION OF THE SOFTWARE WILL BE UNINTERRUPTED OR ERROR-FREE. HOWEVER, TAIS WARRANTS THAT ANY MEDIA ON WHICH THE SOFTWARE IS FURNISHED IS FREE FROM DEFECTS IN MATERIAL AND WORKMANSHIP UNDER NORMAL USE FOR A PERIOD OF NINETY (90) DAYS FROM THE DATE OF DELIVERY TO YOU.
- 5. Limitation of Liability.** TAIS’ ENTIRE LIABILITY AND YOUR SOLE AND EXCLUSIVE REMEDY UNDER THIS LICENSE AGREEMENT SHALL BE AT TAIS’ OPTION REPLACEMENT OF THE MEDIA OR REFUND OF THE PRICE PAID. TO THE MAXIMUM EXTENT PERMITTED BY APPLICABLE LAW, IN NO EVENT SHALL TAIS OR ITS SUPPLIERS BE LIABLE TO YOU FOR ANY CONSEQUENTIAL, SPECIAL, INCIDENTAL OR INDIRECT DAMAGES FOR PERSONAL INJURY, LOSS OF BUSINESS PROFITS, BUSINESS INTERRUPTION, LOSS OF BUSINESS INFORMATION/DATA, OR ANY OTHER PECUNIARY LOSS OF ANY KIND ARISING OUT OF THE USE OR INABILITY TO USE THE SOFTWARE, EVEN IF TAIS OR ITS SUPPLIER HAS BEEN ADVISED OF THE POSSIBILITY OF SUCH DAMAGES. IN NO EVENT SHALL TAIS OR ITS SUPPLIERS BE LIABLE FOR ANY CLAIM BY A THIRD PARTY.
- 6. State/Jurisdiction Laws.** SOME STATES/JURISDICTIONS DO NOT ALLOW THE EXCLUSION OF IMPLIED WARRANTIES OR LIMITATIONS ON HOW LONG AN IMPLIED WARRANTY MAY LAST, OR THE EXCLUSION OR LIMITATION OF INCIDENTAL OR CONSEQUENTIAL DAMAGES, SO SUCH LIMITATIONS OR EXCLUSIONS MAY NOT APPLY TO YOU. THIS LIMITED WARRANTY GIVES YOU SPECIFIC RIGHTS AND YOU MAY ALSO HAVE OTHER RIGHTS WHICH VARY FROM STATE/JURISDICTION TO STATE/JURISDICTION.
- 7. Export Laws.** This License Agreement involves products and/or technical data that may be controlled under the United States Export Administration Regulations and may be subject to the approval of the United States Department of Commerce prior to export. Any export, directly or indirectly, in contravention of the United States Export Administration Regulations, or any other applicable law, regulation or order, is prohibited.
- 8. Governing Law.** This License Agreement will be governed by the laws of the State of California, United States of America, excluding its conflict of law provisions.
- 9. United States Government Restricted Rights.** The Software is provided with Restricted Rights. The Software and other materials provided hereunder constitute Commercial Computer Software and Software Documentation and Technical Data related to Commercial Items. Consistent with F.A.R. 12.211 and 12.212 they are licensed to the U.S. Government under, and the U.S. Government’s rights therein are restricted pursuant to, the vendor’s commercial license.
- 10. Severability.** If any provision of this License Agreement shall be held to be invalid, illegal or unenforceable, the validity, legality and enforceability of the remaining provisions hereof shall not in any way be affected or impaired.
- 11. No Waiver.** No waiver of any breach of any provision of this License Agreement shall constitute a waiver of any prior, concurrent or subsequent breach of the same or any other provisions hereof, and no waiver shall be effective unless made in writing and signed by an authorized representative of the waiving party.
- 12. Supplier Software.** The Software may include certain software provided by TAIS suppliers. In such event, you agree that such supplier may be designated by TAIS as a third party beneficiary of TAIS with rights to enforce the Agreement with respect to supplier’s software.

YOU ACKNOWLEDGE THAT YOU HAVE READ THIS LICENSE AGREEMENT AND THAT YOU UNDERSTAND ITS PROVISIONS. YOU AGREE TO BE BOUND BY ITS TERMS AND CONDITIONS. YOU FURTHER AGREE THAT THIS LICENSE AGREEMENT CONTAINS THE COMPLETE AND EXCLUSIVE AGREEMENT BETWEEN YOU AND TAIS AND SUPERSEDES ANY PROPOSAL OR PRIOR AGREEMENT, ORAL OR WRITTEN, OR ANY OTHER COMMUNICATION RELATING TO THE SUBJECT MATTER OF THIS LICENSE AGREEMENT.

Toshiba America Information Systems, Inc.
Telecommunication Systems Division
9740 Irvine Boulevard
Irvine, California 92618-1697
United States of America

5932

DSD 020905

Toshiba America Information Systems, Inc.
Telecommunication Systems Division
End-User Limited Warranty

Toshiba America Information Systems, Inc., ("TAIS") warrants that this telephone equipment manufactured by Toshiba (except for fuses, lamps, and other consumables) will, upon delivery by TAIS or an authorized TAIS dealer to a retail customer in new condition, be free from defects in material and workmanship for twenty-four (24) months after delivery, except as otherwise provided by TAIS in the TAIS warranty accompanying the products or posted on TAIS's website. Products which are not manufactured by Toshiba but are purchased from Toshiba, will be subject to the warranty provisions provided by the equipment manufacturer, unless TAIS notifies the end-user of any additional warranty provisions in writing.

This warranty is void (a) if the equipment is used under other than normal use and maintenance conditions, (b) if the equipment is modified or altered, unless the modification or alteration is expressly authorized by TAIS, (c) if the equipment is subject to abuse, neglect, lightning, electrical fault, or accident, (d) if the equipment is repaired by someone other than TAIS or an authorized TAIS dealer, (e) if the equipment's serial number is defaced or missing, or (f) if the equipment is installed or used in combination or in assembly with products not supplied by TAIS and which are not compatible or are of inferior quality, design, or performance.

The sole obligation of TAIS or Toshiba Corporation under this warranty, or under any other legal obligation with respect to the equipment, is the repair or replacement of such defective or missing parts as are causing the malfunction by TAIS or its authorized dealer with new or refurbished parts (at their option). If TAIS or one of its authorized dealers does not replace or repair such parts, the retail customer's sole remedy will be a refund of the price charged by TAIS to its dealers for such parts as are proven to be defective, and which are returned to TAIS through one of its authorized dealers within the warranty period and no later than thirty (30) days after such malfunction, whichever first occurs.

Under no circumstances will the retail customer or any user or dealer or other person be entitled to any direct, special, indirect, consequential, or exemplary damages, for breach of contract, tort, or otherwise. Under no circumstances will any such person be entitled to any sum greater than the purchase price paid for the item of equipment that is malfunctioning.

To obtain service under this warranty, the retail customer must bring the malfunction of the machine to the attention of one of TAIS' authorized dealers within the applicable warranty period and no later than thirty (30) days after such malfunction, whichever first occurs. Failure to bring the malfunction to the attention of an authorized TAIS dealer within the prescribed time results in the customer being not entitled to warranty service.

THERE ARE NO OTHER WARRANTIES FROM EITHER TOSHIBA AMERICA INFORMATION SYSTEMS, INC., OR TOSHIBA CORPORATION WHICH EXTEND BEYOND THE FACE OF THIS WARRANTY. ALL OTHER WARRANTIES, EXPRESS OR IMPLIED, INCLUDING THE WARRANTIES OF MERCHANTABILITY, FITNESS FOR A PARTICULAR PURPOSE, AND FITNESS FOR USE, ARE EXCLUDED.

No TAIS dealer and no person other than an officer of TAIS may extend or modify this warranty. No such modification or extension is effective unless it is in writing and signed by the Vice President and General Manager, Telecommunication Systems Division.

WARRANTIES FOR NON-TOSHIBA BRANDED THIRD PARTY PRODUCTS

A valuable element of Toshiba's product strategy is to offer our customers a complete product portfolio. To provide this value to our customers at the most optimal prices, we offer both Toshiba-branded and third-party manufactured products that support our Toshiba Strata CIX product portfolio. Similar to other resellers of software, hardware and peripherals, these third-party manufactured products carry warranties independent of our Toshiba limited warranty provided with our Toshiba-branded products. Customers should note that third-party manufacturer warranties vary from product to product and are covered by the warranties provided through the original manufacturer and passed on intact to the purchaser by Toshiba. Customers should consult their product documentation for third-party warranty information specific to third-party products. More information may also be available in some cases from the manufacturer's public website.

While Toshiba offers a wide selection of software, hardware and peripheral products, we do not specifically test or guarantee that the third-party products we offer work under every configuration with any or all of the various models of the Toshiba Strata CIX. Toshiba does not endorse, warrant nor assume any liability in connection with such third party products or services. If you have questions about compatibility, we recommend and encourage you to contact the third-party software, hardware and peripheral product manufacturer directly.

This page is intentionally left blank.

Contents

Introduction

Organization.....	ix
How to Use This Guide.....	xi
Conventions	xi
Related Documents/Media.....	xii

Chapter 1 – The Grand Tour

IPT2000-series Telephones.....	1
Fixed Buttons.....	3
Flexible Buttons.....	4
LCD / Soft Keys	5
SoftIPT	6
SoftIPT Icons	7
PDA	7
DKT3000/3200-series Telephones	8
Fixed Buttons.....	10
Flexible Buttons.....	11
Liquid Crystal Display.....	11

Chapter 2 – The Basics

Important - Read First.....	13
What's My Line?	13
Which Outgoing/Incoming Call Features Do I Have?	14
Making a Call.....	15
Hot Dialing	15

Contents

Chapter 3 – Advanced Operation

Spkr Button	15
Handset	15
Dial Directory	16
Answering a Call.....	17
Handset	17
Speaker	17
Handsfree Answerback.....	17
Switching Between Handset and Speakerphone.....	17
Message Waiting.....	18
Responding to a Lit Msg LED.....	18
Turning On/Off MW LED on Another Extension.....	19
Microphone	19
Call Transfer	20
Conference Calls	22
Adding Voice Mail to a Conference.....	23
Connecting Two Outside Lines	23
Conference Add/Split/Join/Drop	24
Hold.....	26
Exclusive Hold.....	26
Automatic Hold	26
Consultation Hold.....	26
Volume Control	27
LCD Contrast Adjustments.....	27
Basic SoftIPT Functions	28
Start the SoftIPT	28
Making a Call	28
Switching a Call to Your Headset	29
Creating a Directory	29
Using the Directory to Call.....	29
Labeling Feature Buttons.....	30

Chapter 3 – Advanced Operation

Using Your LCD.....	31
Soft Keys.....	32
Soft Key Example.....	33

Advisory Messages	34
Account Code Calls	35
Verified/Non-Verified Account Codes	35
Forced Account Codes	35
Voluntary Account Codes (Verified/Non-Verified)	36
Alarm Notification Button	37
Automatic Busy Redial	37
Automatic Callback	38
Background Music	39
Call Forward	40
System	40
Station	40
Station Call Forward Categories	41
Call Forward Settings	41
Station Call Forward Procedures	42
Call Forward Examples	43
Call History	47
Call Park Orbits	47
Call Pickup	49
Group Pickup	49
Ringing, Page or Held Call Pickup	49
Call Waiting	51
Direct Inward System Access (DISA)	52
Direct Station Selection Buttons (Hotline)	52
Distinctive Ringing	53
Do Not Disturb	54
Setting DND for Another Extension	55
Door Lock(s)	55
Door Phone(s)	56
Echo Cancellation	57
Emergency Call	57
Emergency Monitoring Station	57
Emergency Ringdown	58
Language Codes	58
Microphone Cut-Off	58

Contents

Chapter 4 – IPT2010-SDC

Off-hook Call Announce.....	59
Override Calls	60
Busy Override.....	60
Do Not Disturb Override	60
Executive Override	61
Destination Restriction/Traveling Class Override.....	61
Class of Service Override	62
Privacy Override.....	62
Paging	62
Answering a Page	63
All Call Page.....	63
Emergency Page	63
Privacy	64
Redial	64
Speed Dial.....	65
Making a Call Using Speed Dial	65
Accessing System SD and Personal SD Directories.....	66
Storing a System/Station Speed Dial Number	66
Advanced Speed Dial Operation	67
Tone/Pulse Dialing.....	68
Uniform Call Distribution.....	69
Login/Logout	70
Voice Mail - Direct Transfer.....	71
Voice Mail Soft Keys.....	71
Call Recording	76
Other Voice Mail Features.....	77

Chapter 4 – IPT2010-SDC

Making and Answering Calls.....	80
Local Emergency Service (Calling 911).....	81
ACO Volume Control	82
Microphone	82
ACO LED and LCD Indication	83
ACO Hold	84
ACO Operating Summary.....	85

IPT2010-SDC Programming86
 IPT Initialization.....88
 IPT2010-SDC Headset Transmit Level Adjustment.....88
 Local CO Line Connection89
 Local CO Line Circuit Quick Test.....90

Chapter 5 – IPT2008-SDL LCD Features

Buttons92
 Fixed Buttons.....92
 Navigation Buttons92
 Idle Display93
 Left and Right Tab Soft Keys.....94
 Directory and Speed Dial Listings.....95
 Direct Station Selection95
 System Speed Dial and Personal Speed Dial.....96
 Internal Directory and External Directory96
 Storing Personal Speed Dial Names97
 Web Access.....99
 Info Manager™.....101
 Stocks.....102
 Weather.....103
 News104
 Calendar.....105
 Cycle.....107
 Configure.....107

Chapter 6 – DKT3014/3214-SDL LCD Features

Directory and Speed Dial Listings.....114
 Direct Station Selection114
 System Speed Dial and Personal Speed Dial.....115
 Internal Directory and External Directory115
 Storing Personal Speed Dial Names116

Chapter 7 – FeatureFlex

Alarm Clock.....	120
Voice Mail Call Monitor.....	121
Voice Mail - Return Call.....	122
Screen Call.....	123
One Number Access.....	124
Hot Desk.....	124
FeatureFlex Interactions.....	125

Chapter 8 – User Programming

Programming Feature Buttons.....	127
User Programming Mode.....	128
Flexible Button Codes.....	128
Setting/Changing a Flexible Button’s Function.....	129
One Touch Buttons.....	130
Changing a One Touch Button.....	130
To Use a One Touch Button.....	131
Setting/Changing a Personal Speed Dial Code.....	131
Feature Codes.....	132
LED Indicator Details.....	136

Chapter 9 – ADM/DSS Console

ADM.....	138
Buttons and LEDs.....	138
DSS Console.....	139
DSS Buttons.....	139
Calling a Station.....	140
Transferring to an Idle Station.....	140
Call Transfer with Camp-on.....	141
Call Answering (Outside Line).....	141
Speed Dial.....	141
Paging.....	142
Call Forward Override (DSS Override).....	142
Night Transfer Button.....	142

Appendix A – Centrex Application

Flexible Directory Numbering	143
Centrex Feature Buttons	143
Ringing Repeat.....	143
Delayed Ringing	144

Appendix B – Button Labels

Index	149
--------------------	-----

This page is intentionally left blank.

Introduction

This user guide describes how to use the Toshiba Strata series telephone products with Strata CIX670, CIX200, CIX100, CIX100-S, and CIX40 telephone systems:

- Strata IP telephone (IPT2010-SD, IPT2020-SD and IPT2008-SDL)
- Strata DKT3000- and 2000-series digital telephones
- Strata Digital Add-on Module (DADM)
- Strata IP Add-on Module (IADM2020)
- Strata Direct Station Selection (DSS) console
- FeatureFlex™
- SoftIPT

Organization

- **Chapter 1 – The Grand Tour** provides an overview of the IP and digital telephones.
- **Chapter 2 – The Basics** covers the basic telephone and SoftIPT features that you need to know.
- **Chapter 3 – Advanced Operation** includes an explanation of Soft Key operations. Features are presented alphabetically and, when applicable, include LCD information.
- **Chapter 4 – IPT2010-SDC** includes the details and functioning of the unique Analog Central Office (ACO) button found only on this telephone.
- **Chapter 5 – IPT2008-SDL LCD Features** describes how to use the IPT2008-SDL
- **Chapter 6 – DKT3014/3214-SDL LCD Features** explains features and functions of the DKT3014 telephone.

- **Chapter 7 – FeatureFlex** explains telephone user information for FeatureFlex features.
- **Chapter 8 – User Programming** explains how to program Flexible Button features, set One Touch buttons, change Personal Speed Dial numbers, as well as other user programmable functions.
- **Chapter 9 – ADM/DSS Console** explains how to use these consoles with the available with your Strata CIX system.
- **Appendix A – Centrex Application** describes the Centrex features which may be available with your Strata CIX system.
- **Appendix B – Button Labels** lists the feature button designations of the 3000-series digital telephone models.
- **Appendix C – FeatureFlex Interactions** shows how the FeatureFlex features interact with other FeatureFlex and some CIX features.

How to Use This Guide

This guide provides in-depth instructions for the IPT1020-SD, IPT2000-series, DKT3000- and DKT2000-series telephones and their features. Most telephone users can use the “*Strata CIX/CTX DKT/IPT Quick Reference Guide*” instead of this guide.

Conventions

Conventions	Description
Note	Elaborates specific items or references other information. Within some tables, general notes apply to the entire table and numbered notes apply to specific items.
Important!	<i>Calls attention to important instructions or information.</i>
Extension Number	Press to answer a call to the Extension Number. Each station can have multiple extension buttons. Incoming calls ring the extension button(s) from the top down. For example, station 10's extensions ring 10-1 first, then 10-2, 10-3, and 10-4. A station is considered busy when all extensions are being used. Note The naming convention for DKT assignments within Toshiba is Directory Numbers. For clarity and ease of understanding, the terms Extension Number and Phantom Extension Number will be used in this document in lieu of PDN and PhDN.
Arial Bold	Represents telephone buttons.
+	shows a multiple PC keyboard or telephone button entry. Entries without spaces between them show a simultaneous entry. Example: Delete+Enter . Entries with spaces between them show a sequential entry. Example: # + 5.
Tilde (~)	Means “through.” Example: 350~640 Hz frequency range.
See Figure 10	Grey words within the printed text denote cross-references. In the electronic version of this document (Library CD-ROM or FYI Internet download), cross-references appear in blue hypertext.

Related Documents/Media

Note Some documents listed here may appear in different versions on the CD-ROM or in print. To find the most current version, check the version/date in the Publication Information on the back of the document's title page.

Refer to the following for more information:

- Strata DKT3001/2001 Digital Single Line Telephone User Guide
- Strata DKT/IPT Telephone Quick Reference Guide
- Strata CIX My Phone Manager User Guide
- Strata CIX Application Software and CIX Documentation Library CD-ROM
- Strata CIX eManager Application Software and Documentation Library CD-ROM
- Strata CIX SoftIPT Application and Documentation Library CD-ROM

This chapter familiarizes you with the Digital Key Telephones (DKT) and Internet Protocol Telephones (IPTs) for the Strata CIX. This includes the IPT2000-series, and DKT3000/DKT3200-series telephones for the Strata CIX (model numbers appear on the bottom of your telephone).

Important! *The IP telephones do not work with the Strata CTX28. The DKT3007/DKT3207-SD is specifically designed to work only with the CTX28.*

IPT2000-series Telephones

The IPT2000-series models include:

- IPT2010-SD 10-button with two-line by 24-character LCD with speakerphone.
- IPT2010-SDC 10-button with two-line by 24-character LCD with speakerphone and an ACO button (to access the local analog trunk).
- IPT2020-SD 20-button with two-line by 24-character LCD with speakerphone.

Note The IP Telephony product family also includes a matching Add-on module IADM2020. This Add-on module functions like the DADM. For user instructions, refer to [“ADM” on page 138](#).

The 2000-series IP telephones offer all the same features as the 3000/3200-series digital telephones, except the IPT2010-SD does not support Speaker Off-hook Call Announce (OCA). All the Toshiba IPT2000-series telephones have speakerphones that enable you to place and receive calls without lifting the handset.

The Grand Tour

IPT2000-series Telephones

Toshiba LCD telephones provide easy access to frequently-used features. Prompts guide you through specific tasks. They also provide Outside Line Identification, User Name/Number, Call Duration, Date/Time of Day displays, and the ability to display names and telephone numbers of outside, incoming callers.



IPT2020-SD Telephone

Fixed Buttons

The fixed buttons on your dial pad enable you to perform standard functions quickly and easily. These buttons are described in [Chapter 2 – The Basics](#).

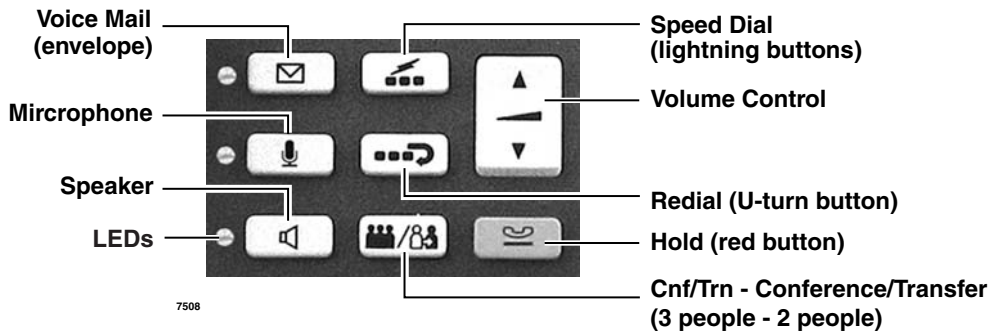

Note The IPT Fixed Buttons work the same way as the DKT telephones, however on the IPTs, fixed buttons have been replaced with button icons.

Flexible Buttons

Your IPT can have 10 or 20 flexible buttons ([Figure on page 2](#)) and the DKTs can have either 10, 14, or 20 flexible buttons that can be programmed to do many button functions, including:

- **Line** is used to access an outside line.
- **Primary Extension** is your extension button.
- **Pooled Line Group** enables you to access available outside lines from a group of lines appearing under one button.
- **Feature Access Buttons** enables you to store features onto a single button.
- **One Touch Buttons** are used for storing Speed Dial numbers or feature access code sequences onto a single button.
- **Voice Mail Call Monitor** lets you listen to a caller while the caller records a message in your voice mailbox.

Note Flexible buttons (FB) are numbered bottom up. See [Table 18 on page 145](#) for a complete list of Feature Access Buttons and One Touch Buttons.

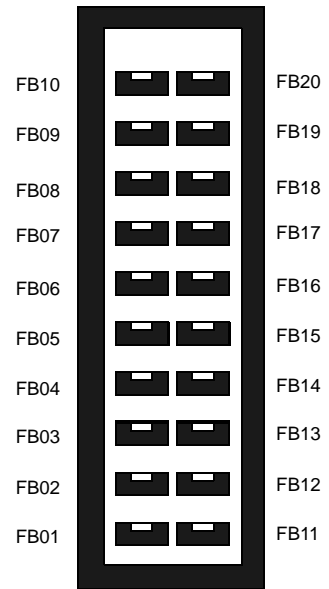

Flexible Button Layout

LCD / Soft Keys

Your Liquid Crystal Display (LCD) (shown below) shows:

- Desk Clock and Calendar in idle mode
- Call Duration during an outside call
- Operational, Advisory, and Notification messages

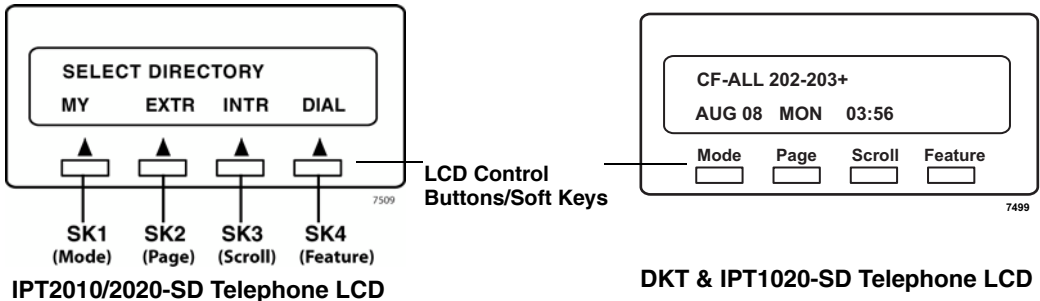

Note The IPT and DKT soft keys perform the same functions. This manual uses the IPT soft keys (SK) to refer to the soft keys on all telephones. For example, if an instruction references SK1, this means use the first soft key (from left to right) on the IPT. SK2, SK3 and SK4 equate to the second, third and fourth soft keys on the IPT or Page, Scroll and Feature on the DKT.

LCD Control Buttons/Soft Keys

There are two types of LCD button functions: LCD Control Buttons and Soft Keys. SK1, SK2, SK3 and SK4 represent the LCD soft keys in this manual.

When the Soft Key prompts appear on the LCD, the LCD Control Button just below the prompt offers access to that feature. See [“Using Your LCD” on page 31](#) for more information.

- SK1 is generally used as a Soft Key.
- Pressing SK2 switches you from the Call Forward (CF) display to the User Name display.
- Pressing SK3 advances you through information.
- SK4 will be used in the future.

SoftIPT

The SoftIPT is a software phone client that runs on appropriately equipped wireless Pocket PCs with Pocket PC 2003 operating software, as well as on wired or wireless laptops, tablets and desktop PCs with the Microsoft® Windows XP® operating software (OS). The Windows XP version of the SoftIPT GUI is shown below.

The Toshiba SoftIPT integrates the power of a PC with all of the features available on a IPT2010-SD and DKT3000/3200-series telephone, except background music. The main difference is that you use a mouse or stylus to select buttons.

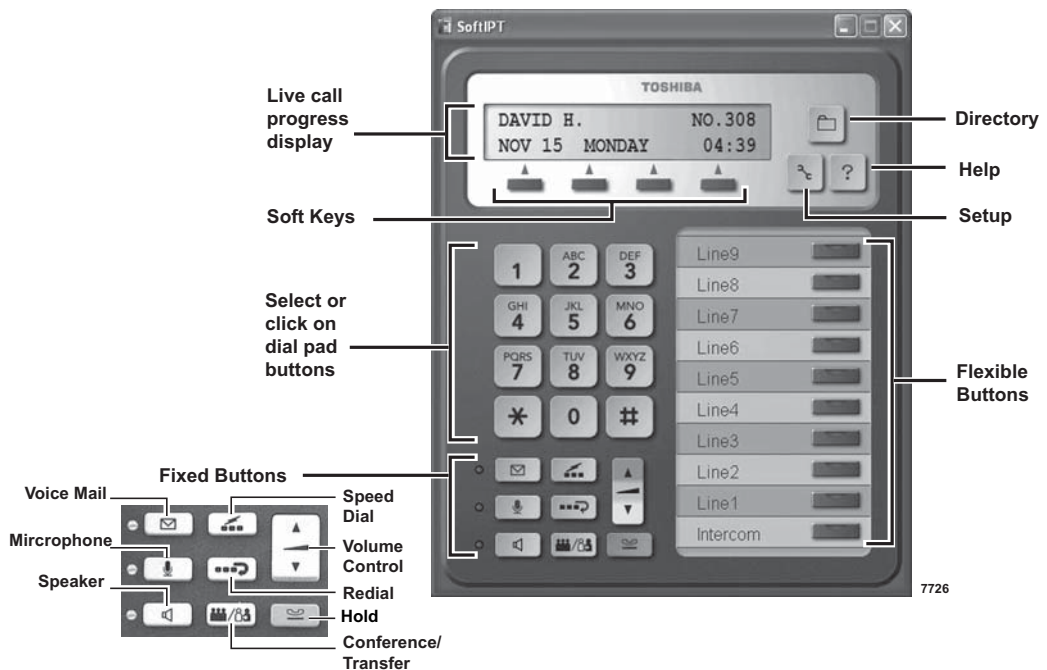

Important! *The SoftIPT functions in the same manner as a desktop IPT. Use this manual as a guide to the SoftIPT functions.*

Refer to [IPT2000-series Telephones](#) for details on Flexible Buttons, Fixed Buttons, Soft Keys and LCD.

SoftIPT basic functions are covered in [Chapter 2 – The Basics](#).

SoftIPT Icons

Directory (Folder) – Clicking this icon enables you to access the directory you create using MS Outlook. Refer to “[Creating a Directory](#)” on page 29.

Setup (Wrench) – Clicking this icon enables you to view and change SoftIPT settings.

Help (Question mark) – Clicking this icon enables you to access Help as a user or find information on Setting Audio Properties, etc. Click Help to view all SoftIPT information.

PDA

You can also install the SoftIPT on a laptop, tablet or desktop PC and a Pocket PC at the same time, but each should have a unique station ID and license.

The SoftIPT works with Toshiba Pocket PC with Windows Pocket PC 2003 OS or higher (shown right),

Tested PDAs

The following PDAs have been tested with the SoftIPT:

- TOSHIBA e750, e755, e800, e805
- HP iPAQ h5550, h5555, hx4700
- Headsets – Plantronics MX 100, MX 150. (see www.plantronics.com/ipaq)



SoftIPT for Pocket PC

DKT3000/3200-series Telephones

The DKT3200-series models that can be connected to a Strata CIX include:

- DKT3001/3201 Single-line telephone.
- DKT3007/3207 CTX28 Button with LCD
- DKT3010/3210-S 10-button with LCD/Speaker
- DKT3007/3210-SD 10-button with LCD/Speaker
- DKT3020/3220-S 20-button Speakerphone
- DKT3020/3220-SD 20-button with LCD/Speaker
- DKT3014/3214-SDL ([page 113](#)) 14-button with eight-line by 24-character tilting LCD and 16 Soft Key buttons.

Note The DKT3000/3200-series Telephony product family also includes a matching Digital Add-on module DADM (DADM3120/3220) and 60-key DSS Console (DDSS3060/3260). For user instructions, refer to [Chapter 9 – ADM/DSS Console](#).

All of the DKT3000/3200-series Toshiba speakerphones enable you to place and receive calls without lifting the handset.

Toshiba LCD telephones provide easy access to frequently-used features. Prompts guide you through specific tasks. They also provide Outside Line Identification, User Name/Number, Call Duration, Date/Time of Day displays, and the ability to display names and telephone numbers of outside, incoming callers.

An illustration of the DKT3020/3220-SD is shown on [page 10](#).



DKT3210-SD Telephone

The Grand Tour

DKT3000/3200-series Telephones



DKT3220-SD Telephone

Fixed Buttons

The fixed buttons on your telephone enable you to perform standard functions quickly and easily. These buttons are described in [Chapter 2 – The Basics](#).

Flexible Buttons

All Flexible Buttons must be programmed for your telephone in system programming and vary for individual telephones. If a button does not appear on your display or telephone keystrip label, see your System Administrator for button assignments.

Line Buttons

You may have buttons designated as Line and/or Pooled Line Grp which enable you to directly access outside lines. Pooled Line Grp enables you to access available CO Lines from a group of lines appearing under one button.

Liquid Crystal Display

Your Liquid Crystal Display (LCD) (shown right) shows:

- Desk Clock and Calendar in idle mode
- Call Duration during an outside call
- Operational, Advisory, and Notification messages

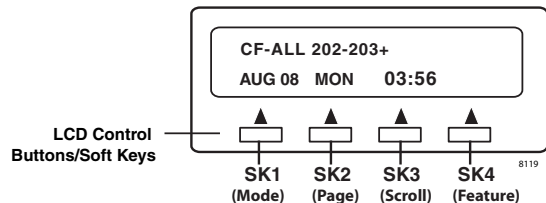

LCD Control Buttons

There are two types of LCD button functions: LCD Control Buttons and Soft Keys.

When the Soft Key prompts appear on the LCD, the LCD Control Button just below the prompt offers access to that feature. See [“Using Your LCD” on page 31](#) for more information.

- SK1 is generally used as a Soft Key.
- Pressing SK2 switches you from the Call Forward (CF) display to the User Name display.
- Pressing SK3 advances you through information.

This page is intentionally left blank.

This chapter shows you the basic operation of your IPT1020-SD, IPT2000-series, and DKT3000/3200-series telephones, unless otherwise noted.

Important! *The IP Telephones do not work with the Strata CTX28.*

Important - Read First

Be sure to check with your System Administrator and make sure you know which features are enabled on your system. Use the check boxes throughout this book to mark which features you have.

Note LEDs on your telephone flash at different speeds depending on the function performed. Flash rates can be found under [“LED Indicator Details” on page 136](#).

What’s My Line?

Throughout this guide, the word “Line” is mentioned. For example, you will be instructed to “select a Line.” “Line” can be:

- Line button
- Pooled Line Group button
- Group Line button
- Line out requiring an access code - where you enter an outside line or line group access code (for example, dialing 9 to get an outside line).

Check mark which Line type you have, then use that selection when instructed to “select a Line.”

Which Outgoing/Incoming Call Features Do I Have?

Check mark here which outgoing/incoming features you have on your system.

Automatic Line Selection (ALS): When making *outgoing* calls, you have ALS if when you lift the handset or press Spkr you hear dial tone and the Line Light Emitting Diode (LED) lights steady green. The LCD displays the station number and the seized outside line.

Ringing Line Preference: You answer an *incoming* line ringing your station by lifting the handset or pressing Spkr. You do not have to press an extension button to answer.

Tone First Signaling: Internal *incoming* call – you hear successive ring tones, then lift the handset or press Spkr to answer the call.

Note Check with your System Administrator to see if you are set with Tone First Signaling. If you do, you can press 2 to change to Voice First signaling.

Voice First Signaling: Internal *incoming* call – your telephone does not ring; instead you hear a long tone, then the caller’s voice. Talk in the direction of your telephone, or answer the call as you normally would by lifting the handset or pressing Spkr.

Note Check with your System Administrator to see if you have the ability to change between Tone and Voice Signaling on a call-by-call basis. If you do, you can press 1 after dialing an internal telephone number to change the signaling.

Hot Dialing: If your telephone is programmed for “hot dialing,” you do not have to press Spkr or lift the handset before dialing internal or external speakerphone calls. When you dial a number, the speakerphone automatically turns on and the Spkr and Mic LEDs light.

Making a Call

There are three ways to originate a call from your IP/digital telephone:

Hot Dialing

1. To make a call using Hot Dialing, dial the number.

When you start to dial, the extension button, Spkr and Mic LEDs light. Digits display as they are dialed. Call progress tones (Ringback Tone, Busy Tone, etc.) play through the speaker.

2. When connected, you can continue speakerphone operation or lift the handset and continue the conversation.

Spkr Button

1. To make a call, press Spkr.

A line may be automatically selected or you can manually choose a line. Your extension or Line button lights (depending on system programming). Dial tone plays through the speaker. The Speaker and Microphone LEDs light.

2. Dial the number.

Digits display as they are dialed. Call progress tones (Ringback Tone, Busy Tone, etc.) play through the speaker.

3. When connected, you can continue to use the speakerphone or lift the handset and continue the conversation.

Handset

1. To make a call, lift the handset, then dial the number.

A line may be automatically selected or you can manually choose a line. Dial tone plays through the handset. The Speaker and Microphone LEDs do *not* light.

Digits display as they are dialed. Call progress tones (Ringback Tone, Busy Tone, etc.) are heard through the handset.

2. When connected, you can continue to use the handset or switch to speakerphone by holding down Spkr and replacing the handset.

Dial Directory

This feature requires CIX R4.0 software and above for Toshiba DKT3000/3200 and IPT2000-series 10- and 20-button small LCD telephones. You can make a call by selecting a name from your telephone directory. Your telephone will display names (First Name, Last Name or vice versa) depending on the way they have been programmed in the telephone system. All directory names are sorted alphabetically.

1. Press SK1 or Mode from your telephone (shown right).

The Select Directory menu appears.

Note The soft keys on the Select Directory are:

- MY = Personal Speed Dial Names
- EXTR = System Speed Dial Names
- INTR = Directory Number Names
- Dial = Cancel directory, get dial tone.

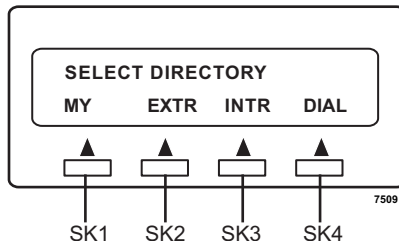

2. Press the appropriate soft key and use the dial pad to enter the first character of the name ...or if you do not select a directory, you can go directly to the dial pad and enter a character. This makes names from all directories available.

Notes

- Press the same dial pad button quickly to move from one character to the next, the characters will change each time the button is pressed. After entering the first character of the name do not press a button, the cursor shifts right so the second character can be entered. The more you spell a name, the system narrows your search.
 - Use the Left or Right soft keys to move the cursor left or right.
Example: To enter the name Jack - Press 5 once for J to display. When the cursor moves to the right press 2 once for A to display. When the cursor moves to the right press 2 three times quickly for C to display. When the cursor moves to the right, press 5 two times quickly for K to display.
3. Press Find soft key to start the Dial-directory search.
 4. Press Next soft key to go through the directory until you see the correct name or extension.
 5. Press Call soft key to call.
 6. Press Back soft key to go back through the directory.

Answering a Call

There are several ways to answer a call:

Handset

- If your telephone is programmed for Ringing Line Preference, pick up the handset and the telephone automatically answers the ringing line.
- If not, press the button associated with the ringing line (flashing green LED).

Speaker

- If your telephone is programmed for Ringing Line Preference, press Spkr and the telephone automatically answers the ringing line.
- If not, press the button associated with the ringing line (flashing green LED). Once connected, you can continue on the speakerphone or lift the handset.

Handsfree Answerback

If you have a speakerphone, it may be programmed for Handsfree Answerback. You hear a single long tone, followed by the caller's voice. The extension LED flashes green (incoming call). The Microphone LED lights steady red (microphone is active). The Speaker LED flashes red.

1. Do not lift the handset; speak toward the telephone in a normal voice.
2. Press Spkr or take the handset off-hook before transferring the call or placing it on hold.

Switching Between Handset and Speakerphone

- Press Spkr and place the handset on-hook to switch from handset to speakerphone mode.
- Take the handset off-hook to switch from speakerphone to handset mode.

Message Waiting

Use your Msg LED/button and LCD to see/retrieve message(s).

An extension can receive up to four simultaneous Message Waiting indications and LCD messages. One message is reserved for the Message Center.

Your telephone can be programmed to have up to four additional (flexible) Message Waiting buttons/LEDs. Check with your System Administrator to see if these buttons have been programmed on your telephone. If so, substitute them when the Msg button/LED is mentioned in the following steps.

Responding to a Lit Msg LED

1. On an LCD telephone, if you see a “+,” press SK3 to display additional messages; otherwise, go to Step 2. The “+” indicates additional messages. The LCD can show up to three station messages for your extension and three for each additional (phantom) extension that you may have.
2. Press Msg, then lift the handset. Your telephone rings the extension or voice mail device that sent the indication. The LED continues to flash red.
3. After answering the message(s), place the handset back on-hook.
4. If the Msg LED continues to flash, you have more messages; repeat Steps 1~3 above to retrieve them. Voice mail devices turn off the LED/LCD indications after a short delay, after you checked all messages.
5. To manually turn off your Msg LED, press your extension button, then press #409. Do this step for each message received.

Turning On/Off MW LED on Another Extension

If you call an extension and it's busy or there is no answer, you may be able to light that extension's Message Waiting LED and enable that extension to call you back. The ability to perform this feature is set in system programming.

1. Dial an internal extension. You hear busy tone or there's no answer.
2. Press **Msg** or **7**. The **Msg LED** flashes red on the called telephone. At your telephone, the **Msg LED** lights steady red and the **LCD** shows the station number where you set a Message Waiting light. Example: "MW SET TO 3620."

If you decide to cancel the Message Waiting light at this point, press **Msg** or **7** again while ring-over tone is playing and the light will be cancelled.

3. Press **Spkr**. Your **Msg LED** turns Off. The **Msg LED** on the called telephone flashes until the called party presses the flashing **Msg** button which calls you back.
4. To turn Off a Message LED that you have set on another extension, press **#64** plus the extension number that has the message light set. Then press **Spkr** or hang up to release your telephone. Your **LCD** shows the extension and "MW CANCEL."

...or dial the extension that you set the Message LED on, then press **77**. Then press **Spkr** or hang up to release your telephone.

Microphone

- To turn the Microphone On/Off when the speakerphone is active (**Spkr LED** is On), press **Mic**.

When the Microphone is On, the **Mic LED** is On, steady red. When **Mic** is Off, the **LED** is Off and you cannot be heard through the microphone.

The microphone and its **LED** are always On when you receive a Voice-first internal call and Off when you receive a Ring-first call.

Each station's microphone can be set in system programming to:

- switch On/Off with one touch
 - switch Off only while pressed and held
 - either On/Off at the start of handsfree dialing.
- To talk back to a Handset Off-hook Call Announce call, press and hold **Mic** and talk over your telephone handset/headset. The **LED** and microphone remain Off.

Call Transfer

1. While on a call, press Cnf/Trn. Your Line LED flashes green and you hear internal dial tone.
2. Dial the extension where the call will be transferred. You can remain on the line and announce the call or immediately “blind transfer” the call.

Note If the privacy option has been disabled, then if you use a Line button when you transfer the call, the LED will flash red until the receiving party answers. While the LED is flashing, you can press Line button to return to the call. If the receiving party answers the call, the LED turns solid red and you cannot reconnect to the original caller.

During call transfer, you can connect all three parties by pressing your flashing extension button or Cnf/Trn.

- If you get voice mail, you can leave a message or hang up and let the transferred caller leave a message.
 - If you hear a long single tone, then announce the call over the called telephone’s speaker.
3. Transfer with Camp On: If the station to which you want to transfer the call is busy, you may hang up and the transferred trunk or station will be camped on to the busy destination.

► To transfer a call directly to Voice Mail (VM)

1. While on a call, press Cnf/Trn.
2. Enter #407.
3. Enter the VM mailbox number (usually the same as the extension number) + #.
4. Hang up and the caller is connected to the VM mailbox. This feature does a blind transfer to VM.

► To transfer a call directly to VM with a DSS button

1. While on a call, press Cnf/Trn.
2. Press the DSS button.
3. Hang up and the caller is connected to the VM mailbox.

► **To perform Call Transfer Immediate**

1. While on a call, press the **TRNS** Soft Key. The IPT2008-SDL and DKT3014/3214 LCD shows “TRANSFER.”
2. Dial the extension where you wish to transfer the call. The call rings the destination station and your telephone returns to the idle state. If your telephone does not go idle, the destination may be located in a remote node, so you need to hang up to return to idle state.

Conference Calls

You can conference together up to eight parties (including your own) - with up to six parties being external network lines. The actual number of conference parties with acceptable volume levels depends on the local and far end telephone line conditions.

The person who initiates the conference call is the Master. If, after the conference is established and the Master exits the conference, the first station to have been added to the conference becomes the Master.

► To conference calls

1. While on a call, press Cnf/Trn. You hear dial tone and your Line LED flashes green.
2. Call another station or outside line.
3. When the called party answers, press Cnf/Trn. If you receive a busy tone or no answer, press Cnf/Trn again to return to the original connection.

All parties are conferenced. If the second call was placed on a Line that appears on your telephone, the LED also flashes green.

4. Repeat the above steps to add lines to the conference. Keep in mind the maximum number of allowed conference parties.

Note When the “master” of the conference hangs up, the control is automatically transferred to the first internal station added to the conference call. If no other internal stations are included in the conference call, the call will be disconnected.

► To transfer conference control

1. Do Steps 1 and 2 above to add the line to which you wish to transfer conference control. See previous Note.
2. Announce the call and hang up to transfer it. This station now becomes the conference “master” with the ability to add or delete parties.

► To hold a conference call

- If you are the Conference Master, press the HOLD button once (or twice for Executive Hold) to place the conference call on hold. The other parties can continue with the conference. Music-on-hold is suppressed and your extension LED flashes green. You can rejoin the conference at any time by pressing your extension button. When you return, you retain Master status.

Adding Voice Mail to a Conference

The Conference Master can add voice mail to a conference. This feature enables participants in a conference to listen to or leave a voice mail message during one telephone call.

► To add Voice Mail to a conference call (performed by Conference Master)

1. Press Cnf/Trn to place the current call on Consultation Hold.
2. Dial the voice mail (VM) extension number, then enter the VM mailbox and security code. This adds the voice mailbox to the conference.
3. Press Cnf/Trn to reconnect to the original party. (You can continue to add conference members by pressing Cnf/Trn and dialing another extension.)

Now, all parties in the conference can listen to or record a message to this voice mailbox. Only the Master can control the VM with touchtones or Soft Keys.

Connecting Two Outside Lines

1. While talking on an outside call, press Cnf/Trn. You hear dial tone. The extension LED flashes (conference rate).
2. Dial an outside line access code and outside telephone number.
3. After the party answers, press Cnf/Trn. The extension LED flashes (in-use rate) and all parties are conferenced.

If you receive a busy tone or if the station does not answer, press the flashing extension button to return to the original connection, press Cnf/Trn.

4. Hang up. The extension LED flashes (exclusive-hold rate) and the two lines are connected. The LED turns Off when the parties hang-up.
5. To supervise a tandem call, press the extension button. If the parties have finished, hang up...or if the parties are still talking, press Cnf/Trn and hang-up. Both Line LEDs turn Off and the connection is released.

If your telephone company provides auto disconnect, the connection may release automatically when the parties hang up. If not, the lines must be supervised to be disconnected.

Conference Add/Split/Join/Drop

If you initiate a conference with two or more parties, you can add outside caller to the conference; or you and another member of the conference can leave (Split) the conference for a private conversation. During this time, other conference members remain connected.

You can then Join both of you back into the conference, or you can Drop (disconnect) the member you are connected to. This feature is performed with Soft Keys if you have a LCD phone with a Split button created on one of your flexible buttons.

This feature also works for remote stations which are connected through Strata Net QSIG.

Important! *You must be a conference master to perform the Add, Split and Drop features. The conference master is the person that initiates the conference call. If that person drops from the conference, the first person added to the conference becomes the conference master.*

► To add an Incoming call to the Conference

1. Place the first caller/Conference on hold.
2. Answer the incoming ringing call.
3. While speaking to the incoming caller, press Cnf/Trn button.
4. Press the blinking DN where the first caller/Conference was placed on hold.
5. Press Cnf/Trn twice to join all parties together.

► **To Split from a conference**

1. While in a conference call on a DKT3000/3200-series phone, press the **SPLT** (Split) soft key or Split button.

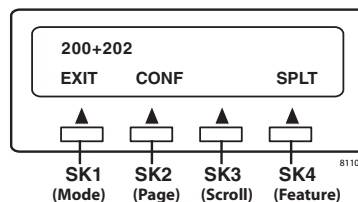

The telephone LCD shows first conference party member. Notice the number **1** preceding extension **200 (1:200)** shown right

2. Press the **NEXT** soft key until you see the extension number for the party that you want to Split out of the conference.

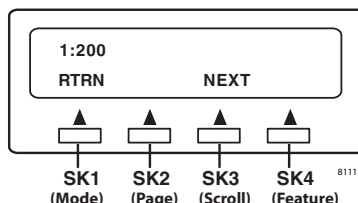

Example, if you want to Split with extension 202, press the **NEXT** soft key until you see **X:202** (X = any number). Then press **X** (in the example shown right **2:202**, press 2 on the dial pad to Split 202.)

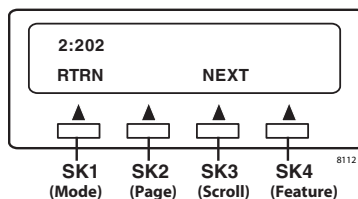

3. You can return both yourself and the other Split party back into the conference by pressing **JOIN**.

RTRN terminates a feature operation and returns to the previously displayed state.

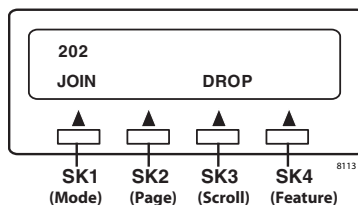

► **To Drop the Split party from a conference**

- Press the **DROP** Soft Key. The party that you are talking to privately (the party which you have Split from the conference) will be disconnected (Dropped) and you will rejoin the conference.

If you are in a three-way conference and Split with one of the parties, the remaining party will essentially be “on hold” until you return to the conference.

Hold

1. To place a call on hold, press **Hold**. Your LCD shows the line on hold. The held Line's LED flashes green while appearances of the line at other stations flash red.
 - To return to the held call, press the held Line button.
 - If you do not return to the held call within a specified time, it rings back to your telephone. The call remains camped-on to your station indefinitely.
 - If the held party hangs up, the call is released.
2. Repeat Step 1 to place additional lines on hold.

Note See the Call Pickup section to pick up a call on hold from another extension.

Exclusive Hold

This feature enables you to place a call on hold so that only you can retrieve it.

- While on a call, press **Hold** twice. That line's LED flashes green while appearances of the line at other stations are steady red (in use).

Automatic Hold

This feature enables you to place a call on hold by pressing another Line button – no need to press **Hold**. Make sure this feature is programmed on your system; if not, existing calls will drop.

- While on a call, press another extension button to receive/originate a new call. The accessed line's LED flashes (in-use). The first call is put on hold and your extension's LED flashes. You can also switch between calls without having to press **Hold**.

Consultation Hold

1. While on a call, press **Cnf/Trn**. The call goes on hold.
2. Dial another line.
3. Transfer the call or return to the held call by pressing its Line button.

Volume Control

- **To adjust the handset volume**
 - Press the Vol ▲ to increase volume and Vol ▼ to decrease volume during the call. When you hang up, the volume returns to the default setting.
- **To adjust the speaker volume for internal/external calls and background music**
 1. Press Spkr.
 2. Press an extension button - you hear dial tone.
 3. Press the Vol ▲ to increase volume and Vol ▼ to decrease volume. This volume setting applies to all calls until changed.
- **To adjust Ring Tone, Handsfree Answerback and Speaker Off-hook Call Announce**
 - Make sure the telephone is idle and the handset is on-hook. Press the Vol ▲ to increase volume and Vol ▼ to decrease volume. This adjusts volume for your telephone's ring tone, Handsfree Answerback and Speaker Offhook Call Announce simultaneously.
- **To adjust handset Beep Tone**
 1. With the handset off-hook, dial the Beep Tone Adjustment Code #6101 (default code). You hear busy tone.
 2. Press Vol ▲ or ▼ to reach the desired level.

LCD Contrast Adjustments

- Press and hold down the Mic button, and press and release Vol ▲ or Vol ▼ repeatedly.

Each time you press Vol ▲ or Vol ▼, the contrast increases or decreases. There are eight steps in either direction. To return to the middle setting, repeat the above step.

Basic SoftIPT Functions

See [Chapter 1 – The Grand Tour, page 6](#) for an overview of the SoftIPT.

Start the SoftIPT

- On a PC, double click on the SoftIPT icon on your PC desktop.
- On a Pocket PC, click Start > SoftIPT.

Making a Call

- **To make a call**
 1. Click Speaker then select the on-screen dial pad buttons to dial a call.
 2. When connected to a call, you can select any of the call buttons, such as Redial, Hold or Conf.
 3. Click Speaker to end the call.

Note Do not use BGM (#490) on the SoftIPT. It conflicts with incoming calls.

Select or click on dial pad buttons to call.

Click Speaker, then dial

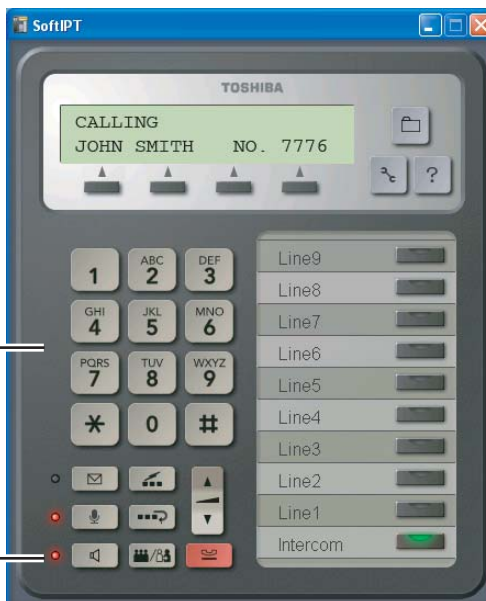

7797

Switching a Call to Your Headset

You can switch a call from your IPT2010-SD, IPT2020-SD, or DKT3000/3200-series digital telephone to the SoftIPT by placing the call on Hold and using the Call Pickup feature.

1. Press HOLD on your digital telephone.
2. On the SoftIPT, dial #5#72 + the extension number of your digital telephone.

Note You can also add this dialing string to a flexible button on your SoftIPT phone as a One-touch Speed Dial button for ease of call switching.

Creating a Directory

You can create a directory with MS Outlook 2002/2003 (not Outlook Express).

1. Open MS Outlook 2002/2003.
2. Double click on the Contacts icon, click on the New contact icon.
3. Type in the contact information, click Save and Close. Add as many entries as desired. To edit an entry, double click on the name to open.
4. Open the Soft Phone.
5. Click More Features twice, click Directory (Folder icon). The directory displays (see below).

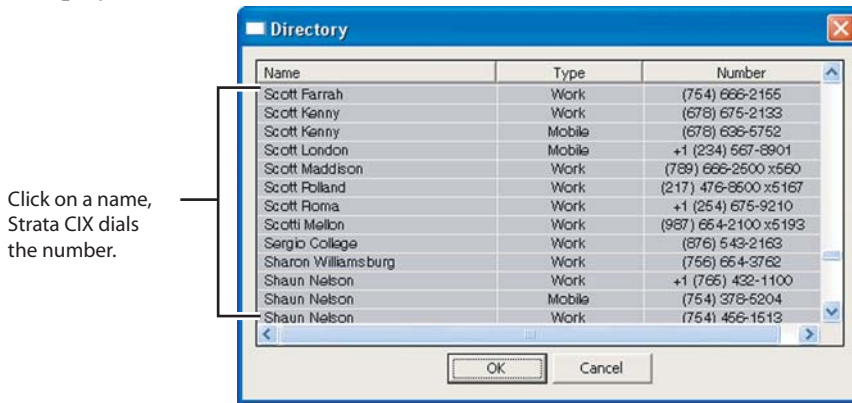

Using the Directory to Call

- Click on the name. The SoftIPT calls the contact.

Labeling Feature Buttons

From the Softphone Setting window, you can change six telephone button labels on a PDA and 10 on a PC. Changing the label does not change the function. To change the function, see “Programming Feature Buttons” on page 127.

Note If the headset-use feature is enabled, Line 5 (PDA) and Line 9 (PC) is set as default and will automatically be labeled headset.

➤ **To find out what features are assigned to the feature buttons**

1. Dial #9876 to enter user programming mode.
2. Click on HOLD, then click on each individual feature button to see the currently programmed feature.

Note If you reprogrammed the button functions per the instructions in the user guide, you cannot manually exit from “programming mode.” Just wait a few seconds for the system to time out and the SoftIPT will return to idle.

3. To exit user programming mode, wait 15 seconds and programming mode will exit automatically.

➤ **To change Feature Button Labels on the SoftIPT**

1. Click the Setup icon (wrench).
2. From the Softphone Setting window (shown right), type in button labels (eight characters max.), click OK.

Can enter labels to rename Lines 1~9 Feature Buttons.

This chapter gives you more details about your IPT2000-series and DKT3000/3200-series telephone's advanced functions.

Using Your LCD

If your telephone has an LCD, use this section to learn more about its functions.

In its idle state, the LCD is a desk clock and calendar. When you are on an outside call, the call duration displays.

A “+” on the LCD readout (shown at right) indicates there is more data to display.

- Press SK3 to advance through the information.
- Press SK2 to switch from the Call Forward (CF) display to the User Name display.

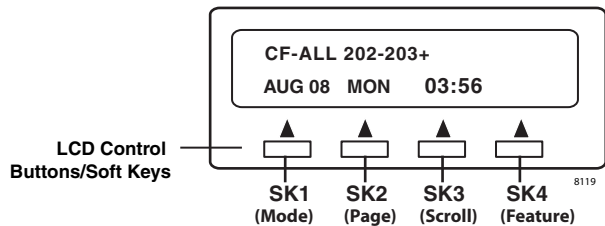

Soft Keys

When Soft Keys are on, they replace the functions on the SK1, SK2, SK3 and SK4 buttons below the LCD. The following table defines Soft Key Prompts.

Table 1 Soft Key Prompts

Soft Key	Definition
ABR	Activates Automatic Busy Redial after dialing a busy outside telephone number.
ACB	Activates Automatic Callback after reaching a busy station, CO line, or CO Line group.
BUSY	(Busy Override) Sends a call-waiting tone to a busy station.
CONF	Initiates or completes a conference.
EXEC	(Executive Override) Breaks into the conversation of a busy called station.
EXIT	Exits you from a conference; remaining parties are connected.
JOIN	Joins all parties to a conference while on a conference call.
LINE	Adds a CO line to an existing call while in the Conference mode. The LCD prompts you to access a CO line after you press this key.
MESG	Sets a message waiting indication at a busy or unanswered station.
OVRD	Overrides options, busy mode, or overrides Do Not Disturb mode.
PGE	Enables you to enter a Page Group number (01~16).
RING	Makes a called station ring when making a voice announce call to the station.
RLS	Disconnects a call and returns telephone to the idle state.
RTRN	Terminates a feature operation and to return to a previously displayed state.
SPLT	Enables you to break off from a conference call with another conference call member for a private conversation (split). You can use the Join key to reconnect both of you back into the conference. You must be a conference master to use this. See instructions for Conference Split/Join/Drop for further instruction.
STA.	Adds a station to an existing call while in the Conference mode. The LCD prompts you to dial a station number after you press this key.
TALK	Makes a voice announcement to a called station that is ringing.
TRNS	Initiates or completes a Transfer while on an outside call. Press once for an immediate or announced transfer, depending on system programming. Pressing TRNS again completes the transfer.

Soft Key Example

When the Soft Key prompts appear on the LCD, the LCD Control Button just below the prompt offers access to that feature. Here's an example of how Soft Keys work.

1. When an outside call is in progress, the LCD appears as shown on the right.

ABR = Automatic Busy Redial
CONF = Conference
PAGE = Paging

2. If you select **CONF** (press SK2), the display changes as shown right.

LINE = Add an outside line to the conference
STA = Add another station
RTRN = Return to the original caller without making a conference

3. You will be prompted to dial the desired station. The **RTRN** Soft Key (press SK3) enables you to return to the original caller without making a conference.

Until the call is answered, you see the screen shown right.

When the call is answered, you see the screen shown right. **TRNS** = exit the call and transfer the first party to the second. **JOIN** = create a conference with you and both other parties. **RTRN** = drop the second party and return to a two-way conversation with the original party.

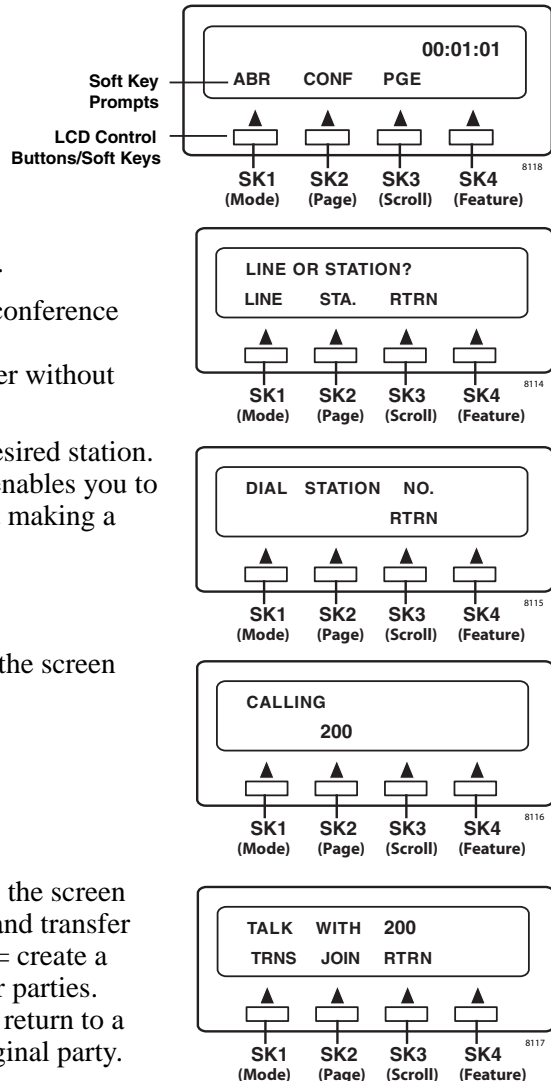

Advisory Messages

Advisory messaging enables you to store an informative message for LCD telephones that call your telephone. The messages can be up to 16 characters long. The Strata system provides a number of stored messages, shown in the table below. Message numbers 5~9 can be defined by your System Administrator.

Msg No.	Characters Displayed	Additional Digits
0	OUT TO LUNCH	
1	IN A MEETING	
2	CALL _____	Directory Number (e.g.,220)
3	BACK AT _____	Time (e.g., 1030)
4	RETURN ON_____	Date (e.g., 10 20)
5		
6		
7		
8		
9		

➤ **To set an advisory message**

1. Go off-hook or press your extension button or phantom directory number button to hear dial tone.

Note A phantom directory number button is similar to an extension button that is shared on other telephones.

2. Press #411 + Message No. (see table) + any additional digits (such as time, etc.)
3. Go on-hook or press Spkr to release the line.

➤ **To clear the registered message**

1. Go off-hook or press your extension button or phantom directory number button to hear dial tone.
2. Press #412.
3. Go on-hook or press Spkr to release the line.

Account Code Calls

Account Codes (Forced or Voluntary) can be used for a variety of reasons including billing, tracking, and line restriction applications. Account Codes are assigned in the system as a fixed length (default is six digits) and are recorded by the system, along with the details of the calls, which can be printed on a Station Message Detail Recording (SMDR) report.

Verified/Non-Verified Account Codes

If programmed for Verified Account Codes, the system checks the account code you entered against a list created by the System Administrator. The code you enter must be on the list for the call to proceed. Non-verified account codes must be of a uniform length specified by the System Administrator.

Forced Account Codes

Some applications require you to enter an Account Code. These Forced Account Codes may be verified or non-verified, depending upon the application, but in either case, the caller must enter a code before proceeding.

► To dial using Forced Account Codes

1. Place a call in the normal method.

If the call requires an Account Code, a burst of tone (Success Tone) is heard after dialing the telephone number alerting you to enter the Account Code.

2. Enter the account number.

When the number of digits designated for account codes has been entered, the number will be checked against the verified list, if chosen, and the call will continue as normal. If the number of digits entered for the account code is not reached or the verified code does not match, then re-order tone is heard and the call is rejected.

You can bypass Forced Account Code requirements with three emergency numbers, including 911. See your System Administrator for these numbers:

- 1) 911
- 2) _____
- 3) _____

Voluntary Account Codes (Verified/Non-Verified)

Voluntary Account Codes are optional. They can be entered during a call and are used for tracking selected calls using Station Message Detail Report (SMDR) call detail recording option.

If the system is set for Verified Account Codes, station users must enter a specific code when entering the Voluntary Account Code(s) or the code is not validated for the SMDR call report. This does not affect the call.

There are two ways to dial using a Voluntary Account Code:

► To dial using the Account Code button

1. After accessing a CO line, press the Account Code button. LCD telephones prompt you to “ENTER ACCOUNT CODE NOW.”
2. Enter the account code digits. The LCD prompt disappears upon entry of the first account code digit. After the account code is entered, the time indicator is restored in the LCD.
3. If your station is set for Verified Account Codes, you hear confirmation tone when the code is valid. If the code is invalid, you hear two short tones.
4. Enter the Account Code. Your conversation is not interrupted.

► To enter an Account Code using access codes

Note It’s a good idea to warn the other party that you will be disconnected momentarily when you enter the access code. Once the code is entered, you will be connected again.

1. After accessing a CO line, press Cnf/Trn. Once you press Cnf/Trn, your call is interrupted; you and the other party cannot hear each other. You will hear feature dial tone.
2. Dial #46. LCD telephones prompt you to “ENTER ACCOUNT CODE NOW.”
3. Enter the account code digits. The prompt disappears upon entry of the first account code digit. After the account code is entered, the connection is restored and the LCD shows the time.

Alarm Notification Button

The Alarm Notification Button must be setup by your System Administrator on your station.

► **When the Alarm Notification button displays**

► Call your System Administrator or Dealer.

This button stops displaying when the alarm clears or when you press the flashing button. If the alarm has not been cleared the Alarm Notification Button starts flashing every 10 minutes.

Automatic Busy Redial

After reaching a busy outside number, you can activate Automatic Busy Redial so that the system automatically redials the number at regular intervals. The system repeats the redial until the destination is no longer busy. This feature may not be on some telephones on your system.

Automatic Busy Redial is not attempted while your station is busy, but continues to time-out. The system inserts a pause (P) on your LCD before redialing the number.

► **To activate Automatic Busy Redial**

1. When you reach a busy number, press Auto Busy Redial or Cnf/Trn + #441. The LED flashes red. You hear confirmation tone.
2. Hang up or press Spkr. The system redials, up to five to 20 times, every 30 to 180 seconds (depending on system programming). Your telephone receives ring tone when Automatic Busy Redial dials the number and it is available. The extension and Spkr LEDs flash green.
3. Lift the handset or press Spkr and wait for the party to answer. If you do not pick up the handset or press Spkr within recall timeout (five to 60 seconds) after a connection is made, you hear a muted ring for another 30 seconds, then the call disconnects.

► **To cancel Automatic Busy Redial**

► Press Auto Busy Redial or extension + #442.

Automatic Callback

When you reach a busy station, you can set Automatic Callback to have the system monitor the busy extension and notify you when it becomes idle.

Automatic Callback can also place you in queue for an available outside line, if you reach a line group in which all lines are busy. When a station or line becomes available, the system rings your telephone. Then when you answer, it automatically rings the intended destination. The amount of time the system will wait for an idle destination is set in system programming. Automatic Callback is also known as “CO Line Queuing.”

► To set Automatic Callback

1. If you hear busy tone after dialing an outside line access code or a station number, press Auto Callback or 4. Busy tone stops, followed by success tone, then busy tone resumes.
2. Hang up. You can make other calls while waiting.
3. When the called station or outside line becomes idle, your telephone rings with a fast LED.
 - If you called a busy station, the extension LED flashes green (incoming call) and the called number displays.
 - If you called a busy outside line, the extension LED flashes green (incoming call rate). The seized line's number displays.
4. Answer within about three rings (can be programmed to ring up to three minutes) to prevent the callback from being cancelled. After you answer, you hear success tone, and the LED flashes green (in-use).

If you hear a busy tone after answering a callback, the called party is already on another call or the line has already been seized or has received an incoming call. Your request is not cancelled. You will be called again the next time a line becomes idle.

If you were attempting to make an outside call, the telephone number is automatically dialed, including the account code or override codes that were used.

► To cancel ACB

- Press Auto Callback or extension button + #431.

Background Music

You can set background music over your telephone speaker or over external speakers. Up to 16 different music sources can be applied to the Strata CIX/CTX system: the first source is Quiet Tone, all others can be music or recorded information.

➤ **To enable background music on your telephone speaker**

➤ Press BGM. LED turns on.

...or press an extension button + #490 + n + #, where n is the music source 1~15.

➤ **To cancel background music on your telephone speaker**

➤ Press BGM. LED turns off.

➤ ...or press an extension button + #491.

➤ **To change the BGM source (1~15) assigned to the BGM button**

Press an extension button + #9876 + BGM + n + BGM, where n is the music source 1~15.

➤ **To enable background music over your external paging speakers**

Press an extension button + #492 + n + #, where n is the music source 1~15.

➤ **To cancel background music over your external paging speakers**

Press an extension button + #493 + Spkr.

Call Forward

There are two types of Call Forwarding that you can set. One is System Call Forward (set in system Programming) which automatically directs calls to a predefined location, such as Voice Mail. See your System Administrator to determine or change your System Call Forward destination.

The other type is Station Call Forwarding. You can use Station Call Forwarding (CF) to replace your System CF destination with a custom CF setting made from your station.

System

System Call Forward directs calls to a destination preset by an Administrator for each telephone, commonly set to voice mail.

- To turn on System Call Forward for your telephone, press #620. Confirmation tone (three short tones) and “DATA PROGRAMMED” indicate the data is set.
- To turn off System Call Forward for your telephone, press #621. Confirmation tone (three short tones) and “DATA PROGRAMMED” indicate the data is set.

Station

Station Call Forward enables you to assign Call Forward destinations for each extension on your telephone that will override the telephone’s System CF settings. Each extension can be independently set Station Call Forward to a unique destination. You can set a Flexible Button to perform any Call Forward function - see [“Programming Feature Buttons” on page 127](#) for more details. Call Forward must be set prior to receiving the call.

The following calls to your station can be forwarded:

- Internal calls
- Auto Attendant calls
- Outside lines that ring only your station
- Transferred internal or incoming line calls

Station Call Forward Categories

You can set Call Forward for the following categories of calls. Within these categories, you can use five different types of Call Forward Settings.

- **Call Forward Any Call** – Forwards any call, whether an internal call or incoming line call.
- **Call Forward - Incoming Line** – Forward incoming line calls only.
- **Call Forward Any Call - Set for Another Station** – Enables you set forwarding of all calls for another telephone within your telephone system.
- **Call Forward - Incoming Line Set for Another Station**– Enables you to set forwarding of incoming line calls for another telephone within your telephone system.

Notes

- Call Forward Any Call and CF-Incoming line can be set simultaneously on a telephone. This allows incoming lines calls to be forwarded to a different destination than all of the other types of calls.
- Call Forward destinations can be to internal destinations and outside telephone numbers.
- You can change your forwarding destination from outside the system using the DISA feature. See your System Administrator for DISA telephone numbers and security code access.

Call Forward Settings

- **Call Forward All Calls** – Forwards all calls immediately.
- **Call Forward Busy/Do Not Disturb** – Forwards calls immediately when your extension is busy or in Do Not Disturb (DND) mode.

In Tone-first systems with multiple lines, Call Forward Busy forwards calls only when all line appearances are in use. In Voice-first systems, Call Forward Busy forwards all calls any time your telephone is in use.

- **Call Forward - No Answer** – Forwards all calls to your station whenever you do not answer the call within a designated time (set by you when you enable the feature).

- **Call Forward Busy/Do Not Disturb/No Answer** – Forwards all calls to your station whenever you are busy, in the DND mode, or after ringing and you do not answer the call within a designated time (set by you when you enable the feature).
- **Call Forward Cancel** – Cancels the set Call Forward feature. Notice that each category of Call Forward has a different code for canceling.

Station Call Forward Procedures

Table 2, “[Call Forward Procedure](#)” contains Call Forward Button sequences. You can do a Call Forward function by, one, entering the button sequence as described, or two, by programming a Flexible Button to perform the sequence. See “[Programming Feature Buttons](#)” on page 127 for instructions on programming a Flexible Button.

► To use the Call Forward button sequence

► Follow the instructions in the following table, shown under “Button Sequence.” Some features require additional input, such as:

- **Dest. Ext. or Telephone No.** – CF destination numbers can be internal extension numbers or outside telephone numbers. If the destination is an outside number, enter the access code used for dialing out (such as 9) + the telephone number + #. The CIX accepts destination numbers of up to 32 digits. (See following examples).
- **Timer** – Enter the number of seconds (08~60) your telephone should ring before forwarding the call. (This is the CF-No Answer timer.)
- **CF Pass Code** – A four-digit Call Forward (CF) pass code established by system programming is required to allow one station to set CF for another station. This code is also used to allow DISA callers to set CF for another station. Users must enter the CF pass code for the station to be forwarded.

Note In [Table 2](#), (tone) means that confirmation tone (three short tones) will play at that point in the sequence to confirm your input was accepted.

Call Forward Examples

➤ **To set your telephone to CF Busy-No Answer to an internal extension number**

- Press your extension button + #6041 + 3000# + 10

#6041 = Call Forward Access Code sequence
 3000# = Internal Extension Number
 10 = Ring time in seconds before Call Forwards

➤ **To set another telephone to CF Busy-No Answer to an outside destination number after a set time**

- Press your extension button + #6042 + 1234 + 1111 + # + 9 + 1 949 5873000 + # + 08

#6042 = CF Busy No Answer Access Code sequence
 1234 = Other telephone's extension number
 1111 = CF Passcode for other telephone + #
 9 = Outside Line Access Code
 1 949 5873000 = 1 + Area Code + Telephone Number
 # = Must press after entering an outside destination number
 08 = Ring time in seconds before Call Forwards

Table 2 Call Forward Procedure

Feature	Button Sequence
Call Forward Any Call - Internal and Incoming Line Calls: Forwards any call, whether an internal call or incoming line call.	
All Calls to an ext.	Press ext. button + #6011 (tone) + dial the dest. ext. no. (tone)
All Calls to outside telephone no.	Press ext. button + #6011 (tone) + outside line access code + dest. telephone no. + # (tone)
Busy to an ext.	Press ext. button + #6021 (tone) + dial the dest. ext. no. (tone)
Busy to outside telephone no.	Press ext. button + #6021 (tone) + outside line access code + dest. telephone no. + # (tone)
No Answer to an ext.	Press ext. button + #6031 (tone) + dial the dest. ext. no. + timer (08~60) (tone)
No Answer to outside telephone no.	Press ext. button + #6031 (tone) + outside line access code + dest. telephone no. + # (tone) + timer (08~60) (tone)

Advanced Operation

Call Forward

Table 2 Call Forward Procedure (continued)

Feature	Button Sequence
Busy No Answer to an ext.	Press ext. button + #6041 + dial the dest. ext. no. # (tone) + timer (08~60) (tone)
Busy No Answer to outside telephone no.	Press ext. button + #6041 + outside line access code + dest. telephone no. + # + timer (08~60) (tone)
Cancel	Press ext. button + #6051 (tone)
Call Forward - Incoming Line Calls: Forward incoming line calls only.	
All Calls to an ext.	Press ext. button + #6013 (tone) + dial the dest. ext. no. (tone)
All Calls to outside telephone no.	Press ext. button + #6013 (tone) + outside line access code + dest. telephone no. + # (tone)
Busy to an ext.	Press ext. button + #6023 (tone) + dial the dest. ext. no. (tone)
Busy to outside telephone no.	Press ext. button + #6023 (tone) + outside line access code + dest. telephone no. + # (tone)
No Answer to an ext.	Press ext. button + #6033 + dial the dest. ext. no. (tone) + timer (08~60)
No Answer to outside telephone no.	Press ext. button + #6033 + outside line access code + dest. telephone no. + # (tone) + timer (08~60)
Busy No Answer to an ext.	Press ext. button + #6043 + dial the dest. ext. no. (tone) + timer (08~60) (tone)
Busy No Answer to outside telephone no.	Press ext. button + #6043 + outside line access code + dest. telephone no. + # (tone) + timer (08~60) (tone)
Cancel	Press ext. button + #6053 (tone)
Call Forward Any Call - Set for Another Station: Enables you to set call forwarding for another telephone within your telephone system. You will need the other telephone's CF pass code in order to do this. CF Pass Codes are created in system programming.	
All Calls to an ext.	Press ext. button + #6012 (tone) + dial the other telephone's ext. no. + enter other telephone's CF pass code + # + dest. telephone no. (tone)
All Calls to outside telephone no.	Press ext. button + #6012 (tone) + dial the other telephone's ext. no. + enter other telephone's CF pass code + # + outside line access code + dest. telephone no. + # (tone)
Busy to an ext.	Press ext. button + #6022 (tone) + dial the other telephone's ext. no. + enter other telephone's CF pass code + # + dest. telephone no. (tone)

Table 2 Call Forward Procedure (continued)

Feature	Button Sequence
Busy to outside telephone no.	Press ext. button + #6022 (tone) + dial the other telephone's ext. no. + enter other telephone's CF pass code + # + outside line access code + dest. telephone no. + # (tone)
No Answer to an ext.	Press ext. button + #6032 (tone) + dial the other telephone's ext. no. + enter other telephone's CF pass code (tone) + # + dest. telephone no. (tone) + timer (08~60) (tone)
No Answer to outside telephone no.	Press ext. button + #6032 (tone) + dial the other telephone's ext. no. + enter other telephone's CF pass code (tone) + # + outside line access code + dest. telephone no. + # (tone) + timer (08~60) (tone)
Busy No Answer to an ext.	Press ext. button + #6042 + dial the other telephone's ext. no. + enter other telephone's CF pass code + # (tone) + dest. telephone no. (tone) + timer (08~60) (tone)
Busy No Answer to outside telephone no.	Press ext. button + #6042 + dial the other telephone's ext. no. + enter other telephone's CF pass code + # (tone) + outside line access code + dest. telephone no. + # (tone) + timer (08~60) (tone)
Cancel	Press ext. button + #6052 (tone) + dial the other telephone's ext. no. + enter other telephone's CF pass code + # (tone)

Advanced Operation

Call Forward

Table 2 Call Forward Procedure (continued)

Feature	Button Sequence
Call Forward - Incoming Line Call - Set for Another Station: Enables you to set forwarding of incoming line calls for another telephone within your telephone system	
All Calls to an ext.	Press ext. button + #6014 (tone) + dial the other telephone's ext. no. + enter other telephone's CF pass code + # (tone) + dest. telephone no. (tone)
All Calls to outside telephone no.	Press ext. button + #6014 (tone) + dial the other telephone's ext. no. + enter other telephone's CF pass code + # (tone) + outside line access code + dest. telephone no. + # (tone)
Busy to an ext.	Press ext. button + #6024 (tone) + dial the other telephone's ext. no. + enter other telephone's CF pass code + # (tone) + dest. telephone no. (tone)
Busy to outside telephone no.	Press ext. button + #6024 (tone) + dial the other telephone's ext. no. + enter other telephone's CF pass code + # (tone) + outside line access code + dest. telephone no. + # (tone)
No Answer to an ext.	Press ext. button + #6034 (tone) + dial the other telephone's ext. no. + enter other telephone's CF pass code + # (tone) + dest. telephone no. (tone) + timer (08~60)
No Answer to outside telephone no.	Press ext. button + #6034 (tone) + dial the other telephone's ext. no. + enter other telephone's CF pass code + # (tone) + outside line access code + dest. telephone no. + # (tone) + timer (08~60) (tone)
Busy No Answer to an ext.	Press ext. button + #6044 (tone) + dial the other telephone's ext. no. + enter other telephone's CF pass code + # (tone) + dest. telephone no. (tone) + timer (08~60) (tone)
Busy No Answer to outside telephone no.	Press ext. button + #6044 (tone) + dial the other telephone's ext. no. + enter other telephone's CF pass code + # (tone) + outside line access code + dest. telephone no. + # (tone) + timer (08~60) (tone)
Cancel	Press ext. button + #6054 (tone) + dial the other telephone's ext. no. + enter other telephone's CF pass code + # (tone)
Change Call Forward Pass Code: Your telephone must be enabled in programming to have the ability to change pass codes.	
Change Pass Code	Press ext. button + #670 (tone) + dial the dest. ext. no. (tone) + old pass code + # (tone) + new pass code (tone) + #

Call History

Incoming calls with Caller ID or ANI information can be optionally recorded into a rolling list for the station where the call is ringing. The call is placed in the list along with the number, name (if provided), time and date of the call, and status of the call (answered, abandoned, or redirected). You can access this list from an LCD telephone with a flexible Caller ID button.

► To view Call History

- When your station is idle, press the Caller ID button. The Caller ID LED lights green and the latest record displays.
- Press Vol ▲ for the next record; press Vol ▼ for the previous record.
- To view the call date, time and status, press SK2 (press again to toggle to call name/number).

Call Park Orbits

The Call Park feature enables you to hold a call temporarily in a location other than your telephone. These areas are called orbits. You or another telephone user can retrieve a parked call from its orbit by specifying the orbit number. You can specify one of 20 General Park Orbits (7000~7019) or a valid extension number within the system.

Once you have parked a call in an orbit, you can:

- Hang up and retrieve the parked call at a later time
- Originate another call
- Access a voice paging device to announce the parked call for pickup from another station

If you park a call and it is not retrieved, it will recall to the parking station and one of the following occurs:

- If your station is idle when the system Call Park recall timer expires, the parked call automatically recalls to your station.
- If your station is busy, the parked call camps on.

If you have an LCD telephone, you can let the system automatically select an available orbit number which displays on your LCD.

► To park a call

1. While on a call, press Park in Orbit
...or Cnf/Trn + #33. The LED flashes green (consultation-hold). If you were on an extension during the call, and you have line button on your telephone, the line LED will flash until the call is picked up (depending on programming).
2. Specify the Park Orbit using one of the following:
 - Press * and the system automatically selects a General Park Orbit between 7000~7019. The chosen orbit appears on the LCD.
 - Enter a valid extension.
 - Press # and the system automatically selects your extension as the orbit.
3. Hang up. The caller's extension or line number and the orbit number are shown. If the parked call is not retrieved within a specified time, the call rings back to your telephone. When a parked call recalls your telephone, the LCD shows the line or extension that is recalling and the orbit number.

► To retrieve a parked call

1. Press Park in Orbit
...or press your extension button + #32.
2. Enter the Orbit Number where the call is parked or # for the extension from which you are calling. You cannot use * to retrieve a parked call. The extension LED flashes at the in-use rate when the call is retrieved.

Call Pickup

You can pick up a call that is ringing another station's extension, a call placed on hold at another station and other types of calls. When you pick up an internal call, the calling station and the called station displays on your LCD.

Group Pickup

Stations can be assigned in system programming to Pickup Groups. As many as 32 groups can be created to enable you to easily pick up incoming (new or transferred) or internal calls that are ringing stations that are in your group or in other groups. This feature does not pick up held calls. See your System Administrator for group assignments.

Ringing, Page or Held Call Pickup

This feature picks up ringing or held calls, including Group Page and All Call Page calls. If these types of calls occur at the same time, the pickup priority is station-to-station and then Page calls in the order of occurrence. In some systems, this feature can be applied to pick up All Call Page exclusively.

► To perform Call Pickup

► Press the buttons shown in the table below for the desired Pickup feature.

Table 3 Call Pickup Feature Codes

Ringing or Page Calls	To Pick Up:	Press Ext. Button, then dial the access sequence below:
Directed DN	A call ringing or held at the Extension Number.	#5#6 + Ext. No.
	A call Ringing, held or parked at the Ext. No.	#5#29 + Ext. No.
Group	A call ringing a member of your pickup group.	#5#34
Directed Ext.	A call ringing on any line of this Primary Ext. No.	#5#5 + Primary Ext. No.
Directed Group	A call ringing an extension in this Pickup Group.	#5#32 + Group No.
Ext. No.	A call ringing this Ext. No. only. Other lines ringing on the same phone are unaffected.	#5#22 + Ext. No.
Outside Calls	Any incoming outside line call.	#5#9

Advanced Operation

Call Pickup

Table 3 Call Pickup Feature Codes (continued)

All Call, Group, and/or External Page	An All Call Page, Group Page and/or External Page by Page Zone or by a specific Ext. No.	#5#36 + Page Zone No. (01~08)
		#5#5 + Ext. No. of another phone being paged.
Held Calls	To Pick Up:	Press Ext. Button, then dial the access sequence below:
Local Retrieve	A call held on this telephone.	#5#71
Remote Retrieve	A call held on another Primary Ext. No.	#5#72 + Primary Ext. No.
Outside Line Retrieve	A call held on this outside line only, regardless of the phone that placed the call on hold. Must enter a three digit outside line no. (e.g., 007).	#5#73 + Outside Line No. (001~128)
Directed Ext. Retrieve	A call held on for this Ext. No., regardless of where this Ext. No. appears.	#5#74 + Ext. No.

Notes

- The Primary extension number is the directory number by which the telephone set is defined. Other, non-primary extension numbers may also appear on the telephone. By convention, the Primary extension number is assigned to the first button on a multi-button telephone.
- If more than one call is on hold, the call on the telephone's lowest button number is picked up.
- Ringing calls are picked up over held calls as a priority.

Call Waiting

You can answer a call that is transferred to your station, even when your station is busy. When another call is camped onto your station, you hear two Camp-on tone beeps and the extension or Line LED flashes red (on-hold).

If a call is sent to your station when busy, and your station does not have an extension button available to receive the call, two camp-on tone beeps are sent to your telephone. You must disconnect or transfer the existing call to answer the waiting call.

➤ **To answer a waiting call by placing the current call on hold**

- Press Hold. The existing call is placed on hold. The camped-on line rings your station (the Line LED flashes green - incoming call)...or if your telephone has the Auto Hold feature, just press the flashing extension button.

You are connected to the transferred call. The extension or Line LED flashes green (in-use).

Note See your System Administrator to find out if you have Auto Hold.

➤ **To answer a waiting call by disconnecting or transferring the current call**

- Hang up or transfer the existing call; the camped-on call rings your station. The camped-on line rings your telephone and the Line LED flashes green (incoming call).

...or press the flashing extension or Line. The existing call is placed on hold. The camped-on line rings your station (the Line LED flashes green - incoming call). This disconnects the current call and connects you to the transferred call. The extension or Line LED flashes green (in-use).

Direct Inward System Access (DISA)

Outside callers with touch tone telephones can call in to lines programmed for Direct Inward System Access (DISA) and dial an extension or outgoing line without going through an attendant or operator. See your System Administrator for details.

1. From outside the system, dial the public telephone number assigned to DISA. The call will be answered and you will hear system dial tone.

If you do not dial within 10 seconds, the line disconnects.

2. When you hear dial tone, dial an extension or an outside line.
3. If you dial an outside destination, you may need to enter a security code provided to you by the System Administrator. When you hear the tone, enter the security code. If accepted, the call will proceed.
4. If you receive busy tone and you want to dial another number while the station is still ringing, press * and repeat Step 2.

Direct Station Selection Buttons (Hotline)

This optional feature enables you to use a DSS button to connect directly to another station's line extension. The DSS LED shows the status (idle/busy) of the station and/or the station's primary extension. For example, a station's DSS button LED shows busy (light steady red) when the station is:

- busy on a call on any button
- idle but all appearances of the station's extension are in use by other stations.

When the station is in DND, the LED flashes red.

► To connect directly to another station's extension

1. When connected to a line or another station, press DSS.

The original party is put on-hold. You can call a station even if the DSS LED shows busy (steady red).

2. Announce the call...or transfer the call by hanging up or pressing Release.

Note You can transfer the call to an idle or busy station.

Distinctive Ringing

► **To set distinctive ringing**

1. Press #9876 to enter User Programming Mode.
2. Press a Line or extension button. The LED is steady green.
3. You can press HOLD to switch between internal and external pitch. (Internal = station calls within your system; external = outside line calls.)
4. Enter the two-digit pitch number (see table):
5. Press the same button that you pressed in Step 2 (Line or extension). Two beeps is a confirmation tone and “DATA PROGRAMMED” displays on your LCD.

Table 4 Internal and External Call Ringing Tones

Tone No.	Frequency and Cadence
01	500 Hz 1 sec. On, 3 sec. Off, repeat
02	1300 Hz 1 sec. On, 1 sec. Off, repeat
11	500/640 Hz 1 sec. On, 3 sec. Off, repeat
12	500/640 Hz 1 sec. On, 1 sec. Off, repeat
13	860/1180 Hz 1 sec. On, 3 sec. Off, repeat
14	860/1180 Hz 1 sec. On, 1 sec. Off, repeat
15	1300/1780 Hz 1 sec. On, 3 sec. Off, repeat
16	1300/1780 Hz 1 sec. On, 1 sec. Off, repeat
17	860/1180 Hz 0.5 sec. On, 1300/1780 Hz 3 sec. Off, repeat
18	860/1180 Hz 0.5 sec. On, 1300/1780 Hz 1 sec. Off, repeat

Do Not Disturb

If your station is in Do Not Disturb (DND) mode, internal, external and transferred calls do not ring your station and Off-hook Call Announce calls are denied. You can continue to make calls while in the DND mode. When originating a call in DND mode, you will hear a short burst of interrupted dial tone followed by continuous dial tone. You can start dialing at any time during either tone.

If you put your Primary extension into DND mode, all calls to that telephone are rejected. If your extension is set for Call Forward-Busy or Call Forward-Busy/No Answer, the call is redirected to the forwarding destination immediately.

If you put an extension other than the Primary extension into DND, only calls to that extension on your telephone will be blocked. Appearances of that extension on other telephones continue to ring.

- **To activate DND on your Primary extension**
 - Press Do Not Disturb or #6091 (hear Success Tone). The LED lights steady red and DND mode is activated for the entire station.
- **To activate DND on a non-Primary extension**
 - Press the desired extension appearance and Do Not Disturb or #6091 (hear Success Tone). The LED lights steady red and DND mode is activated for that extension on your telephone.
- **To deactivate DND**
 - Press Do Not Disturb or #6092 (hear Success Tone). The LED lights goes out and DND mode is de-activated.

Setting DND for Another Extension

➤ **To activate DND for another extension**

- Enter #6191 (hear Entry Tone) + the Primary extension of the remote extension + the pass code + # (hear Success Tone). This sets DND as if activated by the Primary extension on the target telephone.

➤ **To deactivate DND for another extension**

- Enter #6192 (hear Entry Tone) + the Primary extension of the remote extension + the pass code + # (hear Success Tone). This removes DND from the target telephone.

➤ **To change your DND Pass Code**

- Enter #670 (hear Entry Tone) + ext. no. (hear Entry Tone) + old pass code + # (hear Entry Tone) + new pass code + # (hear Success Tone).

If you activate DND while a call is ringing, the ringing stops. The LED continues to flash on your telephone and ring on other appearances.

Door Lock(s)

Your telephone may have Unlock Door button(s). Each Unlock Door button is programmed to unlock a specific door. Check with your System Administrator to find out the locations of your system's door phones and record them below.

Door Lock No.	Location
0	
1	
2	
3	
4	
5	

Door Lock No.	Location
6	
7	
8	
9	
10	

➤ **To unlock a door**

- Press the specific Unlock Door button or #12 + the Door Lock Number (see above table). The door unlocks for three~30 seconds (set in system programming). The Unlock Door LED is lit while the door is unlocked.

Door Phone(s)

Door phones can be used to call phones selected in system programming. When a door phone calls, you hear a distinctive ringing tone, one or five times (set in system programming). You can also call a door phone and monitor the surrounding area.

LCD telephones display the door phone name ID when calls are made to or from door phones.

The number of possible door phones varies by Strata CIX system, 01~24 maximum for larger systems. Check with your System Administrator to find out the names and locations of your system's door phones and record them below.

Door Phone	Name/Location	Door Phone	Name/Location

➤ **To answer a door phone call**

- When you hear a door phone call ringing, lift the handset or press the ringing button. A door phone call sounds like chimes (high/low). The extension LED flashes green (in-use) and you are connected to the door phone.

...or to pick up door phone calls ringing someone else's telephone, press your extension + #5#5 + directory number of the ringing phone.

➤ **To call/monitor a door phone**

1. With the handset off-hook, press an extension button. You hear dial tone and the LED flashes green (in-use).
2. Press #15 (hear three tone bursts), then enter the door phone number (01~24, depending on system size). A two-way talk-path exists between your telephone and the door phone. The door phone will not ring. You can audibly monitor the area around the door phone.

➤ **To call from a door phone**

1. Press the door phone button and then release it. You hear a distinctive ringing tone—one or five times (set in system programming).
2. When answered, speak at a normal voice level in the direction of the door phone.

Echo Cancellation

- If you hear echo on your IP telephone, tap either Vol ▲ or Vol ▼ once to cancel the echo.

Emergency Call

- To make an emergency call, dial 911.

Emergency Monitoring Station

Your system may have one digital telephone assigned as an emergency monitoring station. If your telephone has this assignment, your line LED will flash green when someone makes a 911 call. When you answer the call, you can listen in and participate in the conversation. See your System Administrator for more information on this feature.

Emergency Ringdown

If a station remains off-hook for a programmable period, it can be automatically treated as an Emergency Call and directed to an emergency destination. The station may have partially dialed a number or have dialed no digits at all. Each station is programmed with its specific emergency ringdown destination.

A station number or a group pilot number can be specified as an emergency ringdown destination. In a private network, the station or pilot number must be in the same network node. Remote emergency destination and door phones are not permitted.

Language Codes

This feature enables you to change the language sent from the Attendant Console or from a PC. See your System Administrator to find out if your telephone is programmed with the ability to change languages.

► To change the Language Display

► Enter the Change Language access code #495 + the Language Code (see below).

1: English date format – **MM/DD (YY)**

2: British English – **DD/MM (YY)**

3: French – **DD/MM (YY)**

4: Spanish – **DD/MM (YY)**

Microphone Cut-Off

This feature prevents callers from monitoring the sounds near your telephone when your telephone receives a Handsfree Call or cuts-off the telephone microphone while on a speakerphone call. When the feature is ON, the Microphn Cut-off LED lights steady red and the Mic and Spkr LEDs do not light when your telephone is called. When the feature is OFF, the Microphn Cut-off LED is not lit and your microphone works. The Microphn Cut-off functions on Handsfree Answerback and speaker OCA calls for privacy.

► To turn the microphone ON/OFF

► Press Microphn Cut-off to toggle between ON/OFF.

Off-hook Call Announce

Off-hook Call Announce (OCA) enables you to complete a call to a *busy* digital telephone. Your telephone must be programmed to either announce automatically or to announce after you press a button on your dial pad. The destination telephone must be programmed to accept an OCA. The announcement may be delivered over the handset or the speaker.

Handset OCA Announce can operate on any digital telephone. Speaker OCA requires the addition of a special circuit board inside the DKT speakerphone.

► To make an OCA call

- **Manual** – Dial an extension. When you hear busy tone, press 5 and, after one long tone, you can talk through the speaker of the destination telephone. The person you are calling has answering options described below.
- **Automatic** – If your telephone and the extension you are calling have been programmed for Automatic OCA, you can talk through the speaker of the destination telephone without hearing the busy tone and without dialing 5.

► To answer a Handset OCA call

While you have a call in progress, you hear one tone in your handset to indicate that a second station is calling.

- Press Mic to toggle between the new and original callers.

You talk to the new caller for as long as you hold down Mic. When you release the button, you return to the original caller. In both cases, neither caller can hear the other. Your LCD indicates which station or CO line you are connected to.

► To answer a Speaker OCA call

Note This feature is not available on the IPT2010-SD.

1. While you have a handset call in progress and you hear one tone, this indicates that a second station is calling. The second caller connects to the speaker in your telephone. The Spkr LED flashes and the Mic LED lights. You will be speaking to the first caller through your handset and the second caller through the microphone.
2. To turn off your microphone speaker to the second party, you can press Mic or Microphn Cut-off; the Mic LED turns Off. You will no longer be talking to the second caller, although he/she can still speak through your speaker.
3. Press Mic or Microphn Cut-off again to reconnect to the second caller. You can toggle as often as you choose. If you do not want the first caller to hear your conversation with the second caller, cover the mouthpiece of your handset.

Override Calls

The available override features are:

Busy Override

Ring Over Busy Override enables you to send a muted ring tone to a busy station to indicate a call is waiting. The Busy Override (BOV) muted ring can be programmed for each station to be two muted rings only or continued muted rings until the call is answered. This option applies to the station receiving the muted ring. The muted ring can be sent to the telephone speaker or to the telephone handset/headset and speaker.

► To use Busy Override

- After reaching a busy station, press 2. A muted tone is heard at the busy station, indicating that a call is waiting. The station number displays.

Do Not Disturb Override

Do Not Disturb (DND) Override lets you send a call waiting tone or ringing to a station in DND mode to indicate that a call is coming in. Your telephone may be programmed to block DND Override from other telephones. Your station's LCD shows the station you have called is in the DND mode.

OCA is possible to DND stations from stations that are programmed for DND Override.

► To use DND Override

- After reaching a station in DND mode, press 2. A tone signal is heard at the DND station, indicating a call is coming in. On your station, the LCD shows the station number you have overridden.

Your LCD displays **DND OVR DENY**, if the station you called denies DND Override.

Executive Override

Executive Override enables you to enter an established conversation. Your telephone can also be programmed to block Executive Override from other telephones.

► To perform Executive Override

- After reaching a busy station, press 3

...or, if you have an LCD telephone, use the **OVRD** Soft Key.

You enter a conference with the busy station and the party to whom he was talking. The called parties may hear an optional tone signal prior to your entering the conversation.

Your LCD displays **EXEC OVR DENY**, if the station you called denies Executive Override. If you do not have Override privileges, you will camp on.

Destination Restriction/Traveling Class Override

Enables a station user to override the Destination Restriction or Traveling Class of a particular telephone by entering a pre-determined account code.

► To use Destination Restriction or Traveling Class Override

1. Press 471. Confirmation tone plays and the LCD shows “Enter OVR Code.”
2. Enter the trunk access code or LCR access code.
3. Dial the external telephone number.

Class of Service Override

By dialing a Class of Service (COS) Override code, a user can change a station's set of privileges to one associated with the override code. When the call is terminated and another is attempted from the same station, the original COS is applied. This allows selected users to override restrictions that are placed on any telephone in the system.

► To perform Class of Service Override

1. Access a Primary or Phantom DN. You hear dial tone and the LED flashes at the in-use rate.
2. Press #471. Dial tone stops. Your LCD prompts you to enter a code.
3. Enter the COS Override Code (four digits). You hear dial tone. For security reasons, the override codes are only available on a selected basis. See your System Administrator.
4. Dial a telephone number.

Privacy Override

This feature enables you to enter an established call on a line you share with another telephone. Up to two station users can enter an existing CO line-to-station call (i.e., up to three stations can be connected to a CO line). You can also use this feature if the station that is already connected to the CO line is in the Privacy Release mode.

Station users with Privacy Release can allow stations with the shared button appearance to enter their conversations, even if the station entering the conversation is not programmed for Privacy Override. (see [“Privacy” on page 64.](#))

Paging

Station users can make page announcements to telephones and external speakers. Check with your System Administrator to find out the zone numbers for various paging groups.

► To make a Page Announcement to telephones or external speakers

1. Lift the handset, press extension and enter a paging access code.
2. Make your announcement, then hang up.

► To make a Group Page

- Press Group Page and enter the Group number (01~16)
...or press extension + #31 and enter the zone number.

Answering a Page

- To answer a Group Page, lift the handset off-hook, dial #5#36 and enter the Page Zone number (01~08, depending on your telephone system).
- To answer an External Page Zone, lift the handset off-hook, dial #5#36 and enter the Page Zone number (01~08, depending on your telephone system).

All Call Page

You can make an All Call Page to telephones assigned to the “All Call Page Group.” Stations are assigned to the “All Call Page Group” in system programming.

➤ To make an All Call Page

1. With the handset off-hook, press All Call Page
...or dial #30. This pages all telephones in the All Call Page Group but, depending on system programming, you may or may not page external speakers.
2. Make your announcement then hang up.

➤ To answer an All Call Page

1. Lift the handset off-hook, dial #5#36.
2. Enter the Page Zone Number (01~08, depending on your telephone system).

Emergency Page

An Emergency Page overrides Group Pages or All Call Pages to telephone and external paging devices.

- To make an Emergency Page, lift the handset off-hook, dial #37.
- To make an Emergency Page to a group, lift the handset off-hook, dial #38 and enter the Group number.

Privacy

Privacy controls the ability of more than one person to use the same extension or CO line at the same time. Privacy applies to multiple appearances of extensions, Phantom extensions, outside Lines and outside Line Group buttons. The application of Privacy to individual telephones is controlled in system programming.

By default, the system is private. If you are in a conversation, another telephone with an appearance of the line on which you are talking cannot intrude unless that telephone has been programmed for Privacy Override. In that event, the other telephone may enter and leave the conversation at will. If all users are provided with Privacy Release in Class of Service, the system will function as non-private.

Your telephone may be equipped with a Privacy Release and/or a Privacy on Line button. On a normally private telephone, Privacy Release allows other appearances of your line to join the conversation. On a normally non-private telephone, Privacy on Line allows you to exclude others. The Privacy condition may be toggled at any time during a conversation. At the end of the conversation, the line's privacy condition returns to its original state.

► To use Privacy Release

► While on a CO line call, press Privacy Release. The LED lights red. The outside line flashes at all appearances. When another station user enters the outside line call by pressing a common outside Line, the Privacy Release LED turns Off. To add a third station, press Privacy Release again; the process repeats.

► To set/cancel Privacy

► Press Privacy on Line to set privacy. The LED lights steady red. Others are blocked from entering your outside line calls when they press a common Line ...or press Privacy on Line again to cancel the feature. The LED turns Off.

Redial

Use this button to redial the last number dialed from your telephone.

► To redial the last number, press Redial or *0.

Speed Dial

Speed Dial (SD) enables you to dial a sequence of up to 32 digits with a shorter code. Dial sequences can include telephone numbers, authorization codes, passwords feature activation codes and pauses. Speed Dial may be used to originate a call or invoked after a call is established. There are two types of Speed Dial:

- **Station SD** – Your System Administrator allocates a block of up to 100 personal SD numbers (10 per telephone). You have exclusive use of them and you can create and change them from your own telephone. If you have a IPT3014 telephone, you can assign names to your station SD numbers to appear on the Personal SD Directory display (see your System Administrator or use the procedure for “[Storing Personal Speed Dial Names](#)” on page 116.)
- **System SD** – All telephones in your system can share a list of up to 800 System Speed Dial numbers under the exclusive control of the System Administrator. In some cases, System Speed Dial enables you to reach numbers that you would not be allowed to dial directly from your telephone.

Making a Call Using Speed Dial

There are two ways to begin a Speed Dial Call.

1. Press Spdial on a DKT3000/3200-series digital telephone
...or press the * button on any telephone.
2. Dial the Station or System Speed Dial Number. Station Speed Dial numbers occupy numbers 100~199. System Speed Dial numbers occupy numbers 200~999.

Table 5 Speed Dial Access Codes

Feature	Feature Access Code Sequences
Speed Dial (Dialing an SD number)	
Station ¹	Spdial ² + nnn nnn = 100~199 Station SD bin numbers
System ¹	Spdial ² + nnn nnn = 200~999 System SD bin numbers

1. Stations must be assigned/enabled Speed Dial capabilities in system programming by an Administrator in Program 200-30 (System SD) and Program 200-35 (Station SD).
2. If your telephone does not have a Spdial button, press the * button, then dial the three digit Speed Dial bin number (nnn).

Accessing System SD and Personal SD Directories

Names can be assigned to System and Station (personal) Speed Dial numbers. These directories appear on large screen IPT2008-SDL and DKT3014/3214-SDL telephones only.

► **To access the SD directories**

1. Press the Soft Key next to **SYSTEM SD** or **PERSONAL SD** to view the first screen.
2. Press the **MORE** Soft Key to view following pages; press **PREVIOUS** to page back.
3. To dial from the list, press the Soft Key next to the name. The system calls the number assigned to the name and displays the dialed number.
4. To assign names to your Personal (Station) SD numbers, see [“Storing Personal Speed Dial Names” on page 116.](#)

Storing a System/Station Speed Dial Number

1. Dial #66. The display shows “SPEED DIAL” and you hear Entry Tone.
2. Dial the Station Speed Dial number (100~199) or System Speed Dial number (200~999). The LCD shows your digits and you hear Entry Tone.
3. Dial the telephone number to be stored + #. Include any required access and area codes. The LCD shows “SPEED DIAL” + the Speed Dial Number + destination + #. You hear Success Tone.
4. Release the telephone. To enter another number, repeat the process, starting with Step 1. Refer to [Table 6](#) below.

Example: To store a Station Speed Dial number on Index 100, dial #66 + 100 + 99495833000 + #

Table 6 Feature Access Codes

Feature	Feature Access Code Sequences
Speed Dial (Storing an SD number)	
Station ¹	#66 + nnn + Phone No. ² + # nnn = 100~199 SD bin numbers
System ¹	#66 + nnn + Phone No. ² + # nnn = 200~999 SD bin numbers

1. Stations must be assigned/enabled Speed Dial capabilities in system programming by an Administrator in Program 200-30 (System SD) and Program 200-35 (Station SD).
2. Refer to [Table 7 on page 67](#) to see how to enter* and # into a speed dial phone number.

IPT2008-SDL Name Storage

If you have a IPT2008-SDL phone, you can store names for Personal SD numbers (see [“Storing Personal Speed Dial Names”](#) on page 116).

Advanced Speed Dial Operation

Special Characters

SD numbers may include 0~9, #, * and Pause. For an example on how to use special characters, see [page 131](#).

Table 7 Phone Number Dial String Characters

Entry	Meaning
0~9	0~9
#	End of Speed Dial Number when entering via access code (#66)
*	Escape. “*” functions as an escape key indicating that the number immediately following represents something exceptional. When * is used as an escape character, it consumes one Speed Dial digit. Entering *7 to insert a seven-second pause would use two of 32 characters.
* (1 ~ 9)	A pause from 1~9 seconds. To pause longer than 9 seconds, enter more pause escape sequences. Example: To insert a 17-second pause, press *9*8. A “P” displays denoting a pause in the SD number. In this example, you would see “PP”
* *	* is entered into the speed dial string.
* #	# is entered into the speed dial string.

Long SD Numbers

Up to 32 digits can be stored in one SD number bin. If you exceed 32 digits, the excess are stored in the next higher bin and consume the next sequential SD number.

You can dial the entire string by entering the original SD number. All digits will be sent, including those in excess of 32. If that were Speed Dial Number 100, Number 101 would no longer be available. You are not prevented from storing a new Number 101 but, if you do, Number 100 will be shortened to 32 digits.

Tone/Pulse Dialing

With some older Central Offices, you may have to make calls on outside lines programmed for rotary dial pulses. This feature enables you, while on these lines, to switch to tone dial to access remote equipment (such as an answering machine) requiring touchtones.

Note With ISDN calls, when Tone Dial Select is pressed, all of the digits entered after that point will be sent with touchtones.

► To change Tone Dialing

1. Access an outside line.
2. Dial a telephone number.
3. While on the call, press Tone Dial Select. Although the outside line is programmed for rotary dial pulses, access the outside line and dial the telephone number like any other call described in this user guide.

The Tone LED lights steady red and you are able to send touchtones with your dial pad. The feature is cancelled when the call is completed.

Uniform Call Distribution

Uniform Call Distribution (UCD) provides ACD-like service based on the simplified Distributed Hunt feature. Incoming calls are answered by Voice Mail as the Auto Attendant function or they can be directly routed to the UCD (Distributed Hunt) Pilot number. The caller will dial the UCD Pilot station in response to a prompt. The call will go to the next agent or, if all agents are busy, the call will camp-on to the Distributed Hunt pilot and ring-back tone or Music-on-Hold (MOH) will be sent.

This feature distributes incoming calls to available agents. Agents must be logged into the group to receive UCD calls. The following illustration shows the typical call flow for this service.

1. Agent logs into the UCD group.
2. CIX receives a call from PSTN or extension.
3. The call is routed to voice mail which provides the initial greeting using the auto attendant service.
4. The voice mail can be configured to prompt callers to enter the destination number or to route the call to the pre-determined destination.
5. The voice mail transfers the call to the UCD pilot group.
6. According to the hunting rule (distribute), the call is delivered to an idle agent who logs in to this hunting group.

If no agent is available in the hunting group, the call is queued to the UCD pilot group. The caller may hear the Music on Hold (MOH) or Ring Back Tone (RBT) depending on the configuration. If the call cannot be answered within the preconfigured time, the call is routed to an overflow destination.

Login/Logout

Login and Logout is controlled by the Login key assigned to the agent phone (see *Strata CIX Programming Manual Vol. 1* for details). The Log status is displayed on the Login key as shown below

- **Login** - Key is On Steady
- **Logout** - Key is Off

The Login/Logout feature is applied to the call which terminates to UCD pilot only. Therefore, the call can terminate to agent Prime or Phantom PDN directly even if the agent is in Logout state. Also, Login/Logout can be activated by an access code. The default numbering plan is shown below.

Access Code	Feature
#6061	Login - from Agent Station
#6062	Logout - from Agent Station
#6161 + DN + #	Login - Agent Station (DN) from another station
#6162 + DN + #	Logout – Agent Station (DN) from another station
where DN = the Directory number of the agent station.	

Voice Mail - Direct Transfer

The system enables you to transfer a call directly to a voice mailbox without first ringing that person's telephone.

- **To transfer a call directly to Voice Mail (VM)**
 1. While on a call, press Cnf/Trn. You hear feature dial tone.
 2. Enter #407. You hear entry tone.
 3. Enter the VM mailbox number (usually the same as the extension number), then press #. The call transfers immediately and your extension becomes idle.

Voice Mail Soft Keys

This section provides simple definitions of the Strategy ES (including the Strategy iES32) Voice Mail Soft Keys. Once your telephone is connected to your Strategy ES voice mailbox, the LCD displays the Strategy ES Main Menu options shown in [Table 8](#) below.

You are then able to perform many of the standard Strategy ES voice mail functions using the Soft Keys on your telephone. [Table 9](#) shows a sample of some of the available Soft Keys.

For more information on Strategy ES voice mail features, refer to the *Strategy Voice Processing User Guide*.

Table 8 Strategy ES Main Menu Soft Keys for Strata CIX Telephones

IPT 2008 SDL DKT3014/3214 SDL	DKT3007/3207-SD DKT3010/3210 SD DKT3020/3220 SD IP Telephones	Voice Mail Functions
PLAY MSGS	PLAY	Play Messages
SEND	SEND	Send Messages
MANAGE MBX	MGMT	Manage Mailbox
EXIT		Exit Mailbox
HANGUP	QUIT	Disconnect from Strategy ES

Table 9 Soft Keys for Strata CIX Telephones

IPT 2008 SDL DKT3014/3214 SDL	DKT3007/3207-SD DKT3010/3210 SD DKT3020/3220 SD IP Telephones	Voice Mail Functions
ACCEPT		Confirm automatic copy destination
ADD	ADD	Create a Guest Mailbox
ADD DESTS		Additional Destinations
ADD MBX	ADD	Add a mailbox to the list
ALL MSGS		Copy All Messages
AM?		AM
APPEND	APND	Append recording
AUTO COPY		Set Automatic Msg Copy
BACK UP		Backup (rewind)
BSY GRT REC		Record Busy Greeting
BUSY GREET		Select Busy Greeting (toggle)
CALL SCREEN		Change Call Screening (On/Off)
CANCEL		Cancel recording
CANCEL MSG	CANC	Cancel message and select new destination
CHANGE		Change notification digits
CHG GREETING	GRT	Change Greeting
CONT DELETE		Continuous Delete
CONT PLAY		Continuous Play
DATE & TIME	DATE	Message Date and Time
DELAY TIME		Set Delay Time
DELETE	DEL	Delete the message/guest mailbox
DELETE MBX	DEL	Delete a mailbox from the personal distribution list
DELETE MSG		Delete message (Future Delivery Review)

Table 9 Soft Keys for Strata CIX Telephones *(continued)*

IPT 2008 SDL DKT3014/3214 SDL	DKT3007/3207-SD DKT3010/3210 SD DKT3020/3220 SD IP Telephones	Voice Mail Functions
DESTINATION		Enter automatic copy destination
DIRECTORY	DIR	Directory plus name
DND	DND	Change Do Not Disturb (On/Off)
ENABLE/DISABLE		Enable/Disable: <ul style="list-style-type: none"> • Notification template (toggle) • Automatic copy
END TIME		Set copy End Time
FOLDERS	FLDR	New/Saved message folder
FORWARD	FWD	Forward the current message
FUTURE DLVR		Set Future Delivery, Future Delivery Review
GO FORWARD		Go forward (advance)
GUEST MBXES	GST	Manage Guest Mailboxes
IMM ALL FAX	SNDN	Immediate Fax (all faxes in folder)
IMM THS FAX	SND1	Immediate Fax (current fax doc)
MARK PRIVAT	PRV	Set Private status (On/Off)
MARK URGENT	URG	Set Urgent status (On/Off)
MSG FOLDERS	FLDR	Manage Personal Folders
MSG NOTIFY		Change message Notification
MULTI ENTRY	MULTI	Multiple Destinations
NAME RECORD	NAME	Record your Name
NEXT	NEXT	Play next message
NEXT MSG		Play next message (Future Delivery Review)
NEXT NAME	NEXT	Play next name
PAUSE	PAUS	Pause recording
PAUSE PLAY		Pause playback

Advanced Operation

Voice Mail Soft Keys

Table 9 Soft Keys for Strata CIX Telephones *(continued)*

IPT 2008 SDL DKT3014/3214 SDL	DKT3007/3207-SD DKT3010/3210 SD DKT3020/3220 SD IP Telephones	Voice Mail Functions
PER DST LST	LIST	Manage Personal Distribution Lists
PERSONAL LIST	LIST	Personal distribution list (1~25)
PM?		PM
PREVIOUS		Play the Previous message
PREV MENU	PREV	Return to previous menu
REC COMMENT	COMM	Record a list Comment
RECORD	REC	Record
REENTER		Re-enter automatic copy destination
REENTER NAM	REDO	Re-enter name or Exit
REPLAY		Replay current message
REPLY	RPLY	Reply to the current message
RE RECORD	RREC	Re-record
RESET PWORD	RSET	Reset Guest Password
RETRN RECPT	RTRC	Set Return Receipt request (On/Off)
REVIEW	REVV	Review recording/guest mailboxes
REVIEW LIST	REVV	Review current list
REV OPTIONS		Review Option Settings
SAVE	SAVE	Save the message/recording/changes
SAVE MSG		Save message (Future Delivery Review)
SECURITY COD	CODE	Change Security Code
SELECT NAME	PICK	Select name
SEND MSG	SEND	Send and Return to Main menu
SET DAY		Set the Day (1~31)
SET HOUR		Set the Hour (1~12)
SET MINUTES		Set the Minutes (0~59)

Table 9 **Soft Keys for Strata CIX Telephones** *(continued)*

IPT 2008 SDL DKT3014/3214 SDL	DKT3007/3207-SD DKT3010/3210 SD DKT3020/3220 SD IP Telephones	Voice Mail Functions
SET MONTH		Set up Month (1~12)
SET YEAR		Set up Year (last two digits)
SPCL FUNCT	SPCL	Special Functions
SND ALL FAX	FAXN	Send All Fax (in folder to fax dev)
SND THS FAX	FAX1	Send Current Fax (to fax device)
SPCIAL SEND	SPCL	Special Delivery Options
START TIME		Set copy Start Time
STOP	STOP	End recording
URGENT MSGS		Copy Urgent Messages
USER OPTNS	OPTN	Change User Options
YES		Resume playback

Call Recording

While on an active call, a station user can record the conversation and store it in a Strategy voice mailbox. Recordings can also be paused or restarted. Depending upon the options selected by your System Administrator, you are given either a manual method of recording that allows you to designate the mailbox where the recording will be sent or an auto method that automatically sends the recording to a predefined mailbox that is assigned to the phone you are using. This may be your personal mailbox.

Note Ask your System Administrator which method to use when recording a call.

This feature requires the presence of a Record and a PS/RES (Pause/Resume) button on your telephone. Feature codes are not available.

Important! *Strategy ES mailboxes have a definable time limit on the length of a message can be. If you plan on making lengthy recordings, see your System Administrator so your message recording time can be properly defined.*

► To record a call

1. With a call in progress, press Record.

If you are using the *auto method*, the Record LED flashes rapidly and there is approximately a one second interval (in extreme busy conditions, up to five seconds) before the recording starts and the Record LED changes to the in-use interval flash rate. You are now recording. Continue to Step 3.

...or if you are using the *manual method*, the Record LED flashes green rapidly. Continue to Step 2.

2. (Manual method only) If you want to record the call to the predefined mailbox associated with the phone you are using, press #. The Record LED flashes rapidly and there is approximately a one second interval (in extreme busy conditions, up to five seconds) before the recording starts and the Record LED changes to the in-use interval flash rate. You are now recording.

...or if you want to record this call to another mailbox, enter the mailbox number (usually the extension number). Finish by pressing #. The Record LED flashes rapidly and there is approximately a one second interval (in extreme busy conditions, up to five seconds) before the recording starts and the Record LED changes to the in-use interval flash rate. You are now recording.

3. To stop recording, press Record. The LED turns off and the recording stops. To resume recording at this point, you need to begin a new recording, see Step 1.

Notes

The following notes apply to telephone systems that are networked. For instance, if your company is so large that some departments are connected to one system (node) and others are on another (either in the same building or in another city), the telephones on the other node are considered “remote” stations.

- When a station that started voice recording puts a line on hold (consultation-hold or line-hold), voice recording stops and cannot be resumed.
- When a local Attendant “splits” two callers that were conferenced, voice recording stops. When a remote Attendant “splits” two callers, voice recording is unaffected.
- If a recorded call is put on Line hold, voice recording stops when that held call is picked up by another station. When the held call is in a different node, voice recording is unaffected when the held call is picked up.
- ACD or Attendant call monitoring cannot be used if voice recording is taking place. Conversely, if ACD or Attendant call monitoring is taking place, you cannot use voice recording.

Pause/Resume Recording

You can pause the recording while continuing the conversation by pressing PS/RES. The PS/RES LED flashes red. Your conversation is no longer being recorded.

To resume recording as part of the same message, press the PS/RES button again. You can pause and resume indefinitely throughout the conversation. The only limit may be a message length imposed by the voice mail system.

Other Voice Mail Features

Another voice mail feature lets you to include a voice mailbox in a conference call. See [“Adding Voice Mail to a Conference” on page 23](#). For instructions on the Stratagy Voice Mail features, refer to the *Stratagy Voice Processing User Guide*.

This page is intentionally left blank.

The IPT2010-SDC telephone looks and functions similar to the IPT2010-SD telephone when connected to the Strata CIX. This phone fully supports all the CIX features and services of a regular IPT2010-SD telephone. However, this telephone can have a unique feature button called the Analog Central Office (ACO) button to connect directly to your local Central Office.

Important!

- The telephone must be connected to live AC commercial power or POE (Power over Ethernet) for CIX system and/or local CO line operation.
- Your telephone must be connected to a working local line for local call operation to function (see [Figure on page 89](#) and [“Local CO Line Circuit Quick Test” on page 90](#)).
- When you press the ACO button, you directly connect to the Central Office and you will not be able to access any of your Strata CIX system features.
- The ACO service has some differences compared to your telephone’s CIX service. See [“ACO Operating Summary” on page 85](#) for more details.

WARNING! Avoid using an IPT2010-SDC connected to a CO Line during a thunderstorm. There is a possible chance of an electric shock from lightning. Toshiba recommends disconnecting the CO Line cord from the IPT2010-SDC when lightning is forecast.

Making and Answering Calls

Notes

- The ACO button (FB10) is the top button on the telephone unless it has been repositioned in programming.
- The CIX Extension button is the bottom button on the telephone unless it has been repositioned in programming.

➤ **To make a call from your local ACO service**

1. Press the ACO button to receive local dial tone.
2. Lift the handset and dial the telephone number.

➤ **To answer an ACO call**

- Press the ringing ACO button.

➤ **To make a Call from your CIX Telephone System Line**

1. Lift the handset or press your CIX Extension button to receive CIX system dial tone.
2. Dial 9 plus an external telephone number.

➤ **To make a Call to another extension in the CIX Telephone system**

1. Lift the handset or press your CIX Extension button to receive CIX system dial tone.
2. Dial the extension number.

Local Emergency Service (Calling 911)

The key benefit of using this telephone is its ability to dial your local Emergency service without going through the CIX system.

► To dial your local emergency service 911

► Press the ACO button first, then lift the handset and dial 911.

Important!

- If you dial 911 without pressing the ACO button, the CIX system will process the Emergency service as programmed by your System Administrator. This is especially important if the CIX system is remote to your IPT2010-SDC telephone.

For example, if your IPT2010-SDC is in New York and the CIX system is in Los Angeles, and you do not use the ACO button for the 911 call, the CIX system will process the call as if you were in Los Angeles.

- An operating local CO line cord must be connected to the “Line” jack on the bottom of your telephone.
- The AC power adaptor (LADP2000-1A or 2A) must be plugged into the live 120 VAC Commercial power that is operating and must be plugged into your telephone; or your telephone must be powered by operating Power over Ethernet (POE) LAN connection.

ACO Volume Control

➤ **To adjust the handset/headset volume**

- Press the Vol ▲ to increase volume and Vol ▼ to decrease volume during the ACO call.

➤ **To adjust the Speaker Receiver Volume**

- Press ACO button in On-hook Mode, then press Volume Up/Down button to change the Speaker Receiver volume level.

➤ **To adjust ACO Ringing volume**

There are two ways to adjust ACO ringing volume:

1. When the ACO button is ringing, press the Vol ▲ to increase volume and Vol ▼ to decrease volume.
2. When the IPT is idle, press Hold, then Vol ▲ to increase volume and Vol ▼ to decrease volume.

Microphone

Important! Use only the Handset in ACO mode; Microphone is not available for ACO conversations in Speaker mode.

ACO LED and LCD Indication

Table 10 LED and LCD Indications

ACO Operation	ACO LED Indication	ACO LCD Display
Idle	Blank (Off) – if CO is connected. Red – if CO is not connected.	Default LCD display
In-use or on Hold by other IPTs or devices. WARNING! Red can also indicate that the telephone is not connected to a working CO line	Red	Default LCD display
ACO Hold	Flashing Green	Default LCD display
ACO Ringing	Flashing Green The Ringing LED (located on top right of the phone) is Flashing Red	LOCAL LINE RINGING
No connection to CIX	Red or Green	USING LOCAL LN: IP-FAIL FLASH REL
Answering ACO	I-use Green blinking	USING LOCAL LINE FLASH REL
Accessing available ACO	I-use Green blinking	USING LOCAL LINE FLASH REL
Notes		
<ul style="list-style-type: none"> • Default LCD display is User name, Extension, Month, Date, Day and Time • The Flash and Release (REL) soft keys display only when using the Local line. You can use the Flash soft key for call waiting answer and/or Centrex feature access. The Release soft key disconnects the local CO line. • When in use or on Hold by other IPT's or devices, ACO LED indication is Red. But according to DC characteristic of branched device or branch wiring condition, IPT2010-SDC might not be able to detect In-use of other IPT's or devices. 		

ACO Hold

You can use the Hold button when using the ACO and CIX service. If you have ACO button auto-hold enabled in 3-6-9 programming, the following interactions occur. The default is “No auto-hold.” This default can be changed by performing [Step 7](#) on [page 87](#).

Table 11 Auto-hold Enable Interactions¹

Case Number	Action / Cases when you press ACO Button	Reaction
1	When you are on a CIX call and you press the ACO button	CIX call is placed on Hold. You can return to the CIX call by pushing the held call.
2	When you are on a Conference call and you are the Conference Master and you press ACO button	Conference call is placed on Hold.
3	When you are on a Conference call and you are the Conference member and you press ACO button.	You are cut off from the Conference call.
4	Your local CO line is not connected and you press ACO button.	No operation, No Dial tone
5	You are making an outgoing CIX call and you press the ACO button. ²	Your outgoing call gets disconnected.
6	While dialing to transfer a CIX call and you haven't completed the dialing and you press the ACO button.	The CIX caller is placed on Hold and after you have completed your ACO call, the CIX system will recall you.
7	When you place a CIX call on Hold and press ACO button.	The CIX call is in Exclusive Hold.

1. All interactions occur only when you have ACO Auto-hold enabled in “[IPT2010-SDC Programming](#)” on [page 86](#).
2. If you have the default of No auto hold then the outgoing CIX call is dropped after pushing ACO key. ACO call is dropped after pushing another telephone button.

ACO Operating Summary

The following is a summary of operating characteristics when using the ACO service on the IPT2010-SDC telephone.

- Your LCD will not display Caller ID name and number when receiving a call on your ACO button.
- You do not get CIX tones or CIX LCD displays when you are on an ACO call or during ACO ringing.
- The buttons available on an ACO call are: Hold, Spkr, Volume ▲ and Volume ▼ buttons, the dial pad, ACO Soft keys, flexible buttons, and ADM/DSS buttons and Off/On-hook.

Note Flexible buttons (except ACO) will use CIX operation. If you press a Flexible button when you are on an ACO call, the call will disconnect or go on Auto-Hold.

- You cannot use the Mic, Msg, Speed dial, Redial, and Conf buttons.
- When using the ACO line, you cannot use CIX features such as Call Forward, Speed dial, Redial, Call Accounting, Toll Restriction, LCR, Account Codes, etc.
- If the IPT2010-SDC has power (POE or commercial AC), the ACO line will function even when there is an IP failure. However, if there is a power failure, the IPT2010-SDC will not work.
- If you put an ACO call on Hold, the call will continue to be on Hold even when other shared IPTs answer or release the call. In this case, the user that placed the call on hold must access the ACO line again to clear the held call.
- If there is an IP failure, the IPT will not reset if the ACO is on Hold or is in use.
- When CIX voice calling or paging occurs, the ACO user will not hear the page or voice announce if he is using the ACO line. After the ACO call is complete the IPT user will be able to hear the Page or Voice.
- When Background Music (BGM) is activated, the ACO will mute ring your telephone when a call is received on your ACO button. When using the ACO button, there is no BGM.

IPT2010-SDC Programming

Important! *The IPT2010-SDC must be programmed, using eManager, as a 20 button station (Prog. 204). Feature Button 11 (FB11) must be programmed as a Release button. When the ACO button is pressed the IPT2010-SDC sends Hold and FB11 (Release) to the CIX system. FB12 ~ FB20 must be blank.*

The feature button used as the ACO must be blank (no assignment) in the CIX data base (Prog. 205).

The programming, shown below, must be done at your IPT2010-SDC telephone. This procedure shows only the programming unique to the IPT2010-SDC. For all other programming functions refer to the DKT/IPT Administrator Guide.

► To place your telephone in Programming Mode

1. Press 3+6+9+Hold simultaneously. The LCD displays “PROGRAM MODE” and “SELECT=”
2. Press 4, then press Hold.

Note Your phone will not ring if it receives a call while in Programming Mode.

► Place the phone into programming mode then set the following:

Note Typically, FB20 ~ FB09 will be left at factory default. However, if necessary, use the Scroll key (SK3) to access FB11 through FB20.

1. Press **FB01 – ACO Button position**. Enter the button position, then press **Hold**. Go to the next Step or, if you are finished programming, go to **Step 9**.
Enter 1 ~ 10 (Default = 10, FB10)
2. Press **FB02 – ACO privacy** (Privacy override is not available). Enter the ACO privacy value, then press **Hold**. Go to the next Step or, if you are finished programming, go to **Step 9**.
1 for No privacy (default) – other IPT2010-SDC with the same ACO can access the CO line while it is in use.
2 for Privacy – other IPT2010-SDC with the same ACO cannot access the CO line while it is in use.
3. Press **FB03 – ACO Ringing assignment**. Enter the ring assignment then press **Hold**. Go to the next Step or, if you are finished programming, go to **Step 9**.
2 = Ring (Default)
1 = No ring

4. Press **FB04 – Flash timing (100 ms units)** (Hook Flash to the CO timing is +/- 10 ms). Press **Hold**. Go to the next Step or, if you are finished programming, go to **Step 9**. Flash is used to answer Call Waiting and access Centrex features and should normally be set to default.

1 ~ 20 (Default: 6 (600 ms))

5. Press **FB05 – ACO Pad** - This affects only the CO Line pad level. This is the same function as the pad jumper on the CO Line card. The IPT pad levels are set by the CIX system PAD Table programming. Press **Hold**. Go to the next Step or, if you are finished programming, go to **Step 9**.

2 = 3 dB pad. Set 3dB if the local CO is very close to your telephone connection causing the audio volume level to be too high.

1 = No pad (Default)

Note During installation, leave ACO Transmit and Receive levels (FB20 and FB19) at default. Use FB05 to adjust ACO level. If additional adjustment is needed, then use FB20 and FB19.

6. Press **FB06 – Country Code**, set to 0 for United States and Canada. Press **Hold**. Go to the next Step or, if you are finished programming, go to **Step 9**.
7. Press **FB07 – Auto Hold ACO line** (No Auto Hold releases the ACO line). Press **Hold**. Go to the next Step or, if you are finished programming, go to **Step 9**.

2 = Auto Hold

1 = No auto hold

8. Press **FB08 – LCD Language for ACO**. Select the display language then, press **Hold**.

1 = US English 3 = British English

2 = French 4 = Spanish

9. Press **Hold** again to save the changes.
10. Lift, then replace hand set to exit programming mode.

FB09 ~ FB20 - Do not change.

IPT Initialization

The IPT2010-SDC has a fourth initialization option (FB4). ACO Default.

1. Press 3+6+9+Hold (simultaneously).
2. Press Vol ▲ then press **Hold**.
3. Press FB04. Revert to factory default ACO settings or Use the saved ACO settings. (LED On = revert to factory default, LED OFF = use the saved ACO settings). This will set all the IPT2010-SDC program options to factory default values.

IPT2010-SDC Headset Transmit Level Adjustment

The IPT2010-SDC headset transmit level for ACO and IPT operation are set by programming from the station.

1. Press 3+6+9+Hold (simultaneously).
2. Press # then press **Hold**.
3. Set the headset transmit level using FB1, FB2 and FB3 as shown in the table below.

Headset Transmit Levels					
Transmit Level	FB1	FB2	FB3	IPT Level	ACO Level
Max. (louder)	OFF	OFF	OFF	+12 dB4	+8 dB
	ON	OFF	OFF	+8 dB	+8 dB
	OFF	ON	OFF	+4 dB	+4 dB
(Default)	ON	ON	OFF	0 dB	0 dB
	OFF	OFF	ON	-4 dB	-4 dB
	ON	OFF	ON	-8 dB	-7 dB
	OFF	ON	ON	-12 dB	-7 dB
Min. (softer)	ON	ON	ON	-16 dB	-7 dB

4. Press **Hold** again.

Local CO Line Connection

A local CO line connection and power are required for ACO operation, including E911.

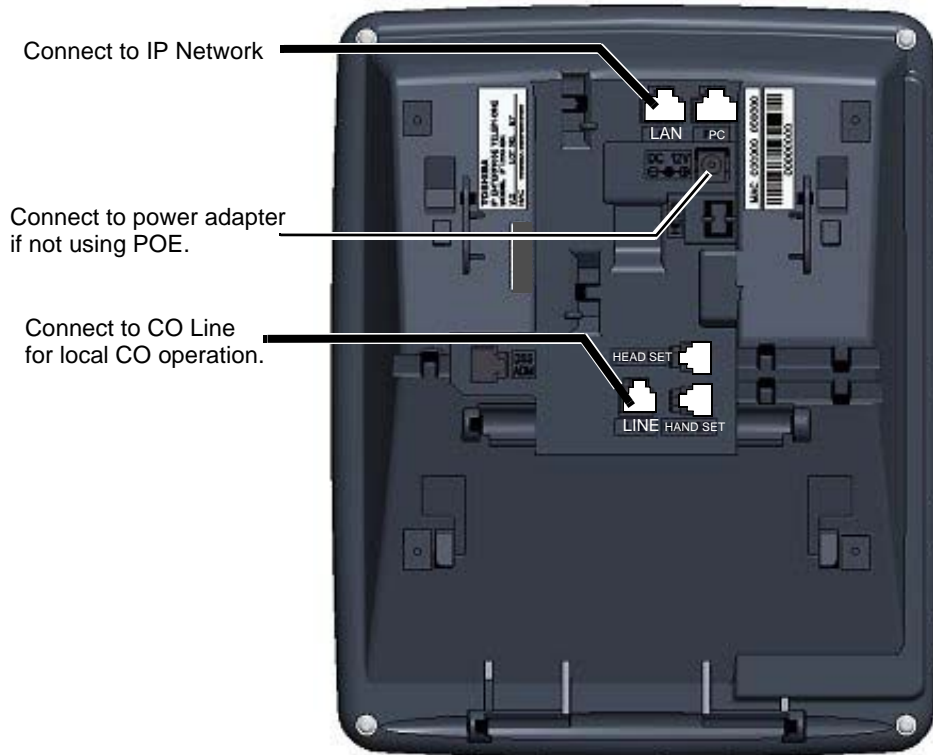

IPT2010-SDC Connections

Local CO Line Circuit Quick Test

This procedure is a quick test to verify the CO Line connection and correct IPT2010-SDC ACO operation. In normal operation the ACO indicator is dark when the ACO line is not in use, red when the ACO is used by another station, and green when the ACO is in use at this station. The ACO indicator that is lit a steady red, when the ACO is not in use, indicates no CO Line connection or a faulty CO Line circuit.

Note The IPT2010-SDC does not require a LAN connection for this test.

1. Apply power to the IPT2010-SDC (POE or local AC adapter). The ACO button will LED will be red.
2. Plug in the local CO Line connection. A functional line will cause the ACO indicator to go dark.
3. Lift the handset then, press the ACO button. Verify that the ACO indicator lights green and dial tone is heard.
4. Dial a local telephone number. Verify two-way speech.
5. Place the handset in the IPT2010-SDC and verify that the ACO indicator goes dark.

IPT2008-SDL LCD Features

5

This chapter shows how to use the IPT2008-SDL (shown below) large screen display.



IPT2008-SDL Telephone

The IPT2008-SDL telephone is unique in functionality and design. This chapter describes its design elements and shows you how this telephone functions.

Buttons

This telephone has Fixed buttons, Navigation buttons, eight flexible buttons and 16 soft key buttons.

Fixed Buttons

The fixed buttons on your dial pad enable you to perform standard functions quickly and easily. These buttons are described in [Chapter 2 – The Basics](#). These buttons are common on all the IPT2000-series telephones.

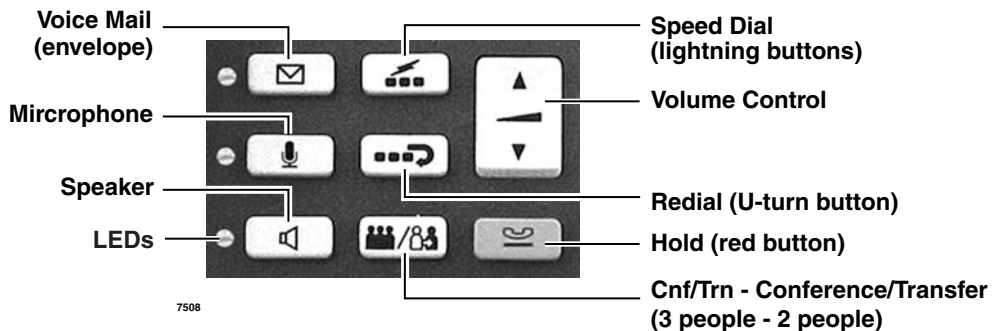

Navigation Buttons

These buttons are found only on the IPT2008-SDL telephone. They are located on the right, between the LCD and the Flexible buttons. You can navigate the Web screen using these buttons.

The Navigation buttons are the ▲ or ▼ arrows to move up or down, the ◀ or ▶ arrows to move left or right and the center button is the Enter button.

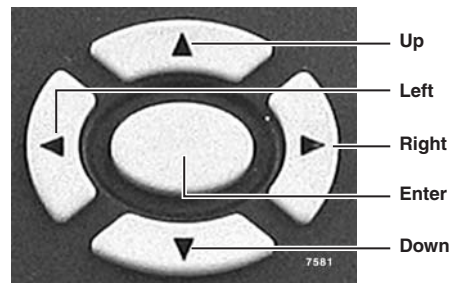

Idle Display

This screen displays the following (for a picture, see [“Directory and Speed Dial Listings” on page 95](#)):

- User Name
- PDN (maximum length is five digits)
- Date and Time (Month, Date, Day)
- Icon – The icon changes according to the Call status
- Soft keys display (see [“Soft Keys” on page 32](#))
- Text information (example: Calling from.)
- Tabs (see [Left and Right Tab Soft Keys](#) below)

Left and Right Tab Soft Keys

Press the Left and Right tab soft keys to navigate to different operations. Using these soft keys, you can tab left to right from Phone, Config and Web and vice versa. The following screens display when you switch from one tab to the other or perform different functions.



7541

Going Off-hook/pressing Speaker

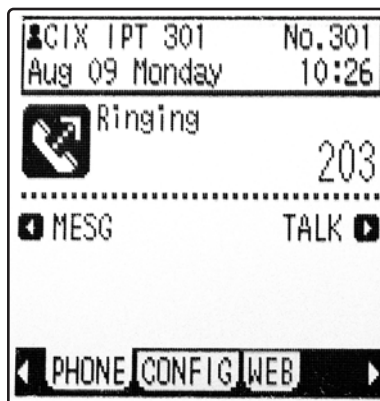

7539

Making an Out-going call



7538

Phone Tab – Talk display



7542

Configuration display

Directory and Speed Dial Listings

The directory menu (idle state) is shown below.

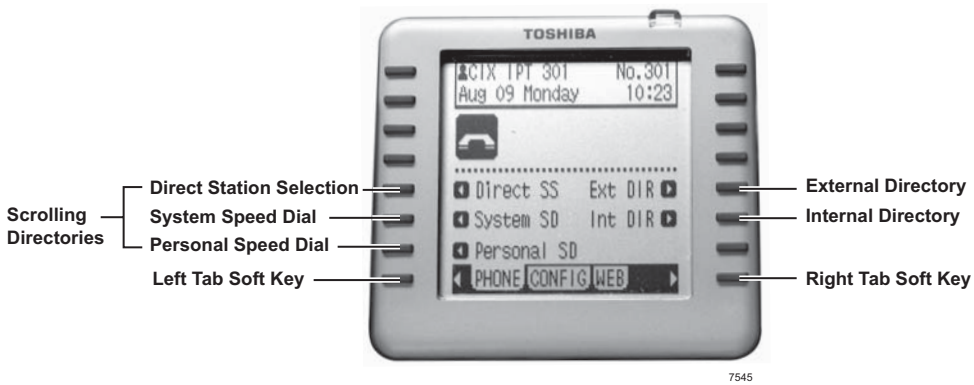

Direct Station Selection

This option displays all named stations in alphabetical order.

1. Press the **DIRECT SS** Soft Key to view the first screen.
2. To view the following page, press the **MORE** Soft Key; press **PREVIOUS** to page back.

MAR 18	MONDAY	01:35
BOB T		
DON U		
CAROL F	FRED M	
CHRIS M	FANK G	
CUST SERV	GRAY W	
PREVIOUS	MORE	
EXIT		

3. To select someone from the list, press the Soft Key next to their name. Press the Talk soft key. The system calls that number.

	3200
MSG	TALK

System Speed Dial and Personal Speed Dial

Using System Speed Dial and Personal Speed Dial is very similar to using Direct Station Selection, described above.

1. Press the Soft Key next to **SYSTEM SD** or **PERSONAL SD** to view the first screen.
2. To view the following pages, press the **MORE** Soft Key; press **PREVIOUS** to page back.
3. To select someone from the list, press the Soft Key next to their name. The system calls that number and displays its directory information.

Internal Directory and External Directory

External Directory enables you to search the System Speed Dial Numbers alphabetically (typically, external destinations). Internal Directory enables you to search all of the internal name extensions alphabetically. This saves time since you do not have to step through the lists screen-by-screen.

See [Table 12 on page 100](#) for instructions on entering letters, numbers and punctuation from the dial pad.

1. Press the **INTERNAL DIR** or **EXTERNAL DIR** Soft Key to view the first screen.

INPUT THE NAME?	
EXIT	FIND

2. Begin by entering the name (see [Table 12 on page 100](#)) and pressing the **FIND** Soft Key.

FRED	
LEFT EXIT	RIGHT FIND

If you entered “B,” all names beginning with “B” are listed. You can press the **MORE** Soft Keys to view adjacent pages.

3. To select someone from the list, press the Soft Key next to the name. The directory information displays.

CUS	
CUSTOMER A	CUSTOMER B
CUSTOMER C	CUSTOMER D
CUSTOMER E	CUSTOMER F
CUSTOMER G	CUSTOMER H
PREVIOUS	MORE
EXIT	

4. Press the Soft Key next to the person or dept. you wish to call. The system calls and displays the directory information.
5. Press any key to return to the idle screen...or, from the directory listing screen, press **EXIT** to return to idle.

SMITH	NO. 200
MAR 18	MONDAY 01:35
TRNS	CONF
PGE	

Storing Personal Speed Dial Names

You can store names with Personal Speed Dial numbers. These names will display as Soft Keys, that can be used for dialing with the Personal SD directory on the IPT2008-SDL telephone.

Note Speed Dial bins (locations) must be assigned to your IPT2008-SDL telephone by your System Administrator before you can store names. Your System Administrator can also associate names with Station Speed Dial numbers.

► To assign Station Speed Dial names

1. Enter User Programming Mode by dialing #9876 or, press Program.
2. Press Spdial. “SPEED DIAL MODE” displays on the LCD.
3. Enter a Speed Dial location number (100~199, depending on system programming).

IPT2008-SDL LCD Features

Directory and Speed Dial Listings

4. Enter the telephone number to be stored. If you normally use a dial line access code (such as 9) and/or an area code, enter the codes before the telephone number.



Example:

Press the  for "A."

Press the  again for "B," etc.

Refer to the table for other characters.

5. Press Spkr, then input the name that will appear in the Personal SD directory (nine characters max).

You can enter alphanumeric characters from the dial pad (shown right and in [Table 12](#)).

To move one character to the right, press the **RIGHT** Soft Key. To add a space, press the **RIGHT** Soft Key twice.

- To backspace (delete previous character), press the **LEFT** Soft Key.
 - To cycle back to the first letter, continue pressing the **LEFT** Soft Key.
6. Press Spdial. The Speed Dial name is now programmed.
 7. Go off hook. The IPT exits User Programming Mode.
 8. Test the Personal SD entry by pressing the **Personal SD** Soft Key. Look for the name in the entry and press the Soft Key associated with that name.

Web Access

► To access the web

1. Tab to the Web display (shown right)
2. Press Mic plus 1
3. To navigate use the “IPT2008-SDL Web Application Icons” on page 100.
4. Press Enter (center button among the Navigation buttons).

Note See “Navigation Buttons” on page 92.

The http: window on screen displays.

The icons shown below are visible on this screen.

5. Press Enter again to enter a number mode. In this mode you can enter an IP Address.
6. Select the Enter Address icon (see “IPT2008-SDL Web Application Icons” on page 100).
7. Enter the IP Address of the Web Server.
8. ...or Press # to enter the Alpha mode. Pressing # lets you toggle between Alpha and Numeric modes.
Refer to “Dial Pad Alphanumeric Characters” on page 100.



Notes

- “A” in the left hand corner of the screen indicates that you’re in Alpha mode.
 - To enter the same letter repeatedly, press the navigation right arrow (after every letter. For example, to type www as in world wide web, use w ►w►w►
9. Enter the web address, press **Enter**, the cursor disappears.
 10. Use the ▼ to click OK, then press the OK soft key.

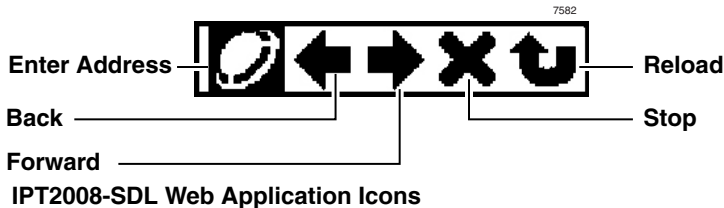

Table 12 Dial Pad Alphanumeric Characters

Dial Pad Buttons	Number of times to press the dial pad button								
	1	2	3	4	5	6	7	8	9
1	space								
2	a	b	c	A	B	C	goto a		
3	d	e	f	D	E	F	goto d		
4	g	h	i	G	H	I	goto g		
5	j	k	l	J	K	L	goto j		
6	m	n	o	M	N	O	goto m		
7	p	q	r	s	P	Q	R	S	goto p
8	t	u	v	T	U	V	goto t		
9	w	x	y	z	W	X	Y	Z	goto w
0 (1st)	.	/	:	@	-	_	~		!
0 (2nd)	"	#	\$	%	^	&	'	()
0 (3rd)	*	+	,	;	<	=	>	?	[
0 (4th)]	'	{		}	goto .			

Press Vol ▼ button to back space
 Press 0 for all punctuation marks
 Press # to toggle between Alpha and Numeric modes
 Press * to enter a period.

Info Manager™

These applications can be used with the IPT2008-SDL telephone or a PC with a web browser. Info Manager Administration details can be found in the *Strata CIX Programming Manual, Volume 3 – Application and Implementation*.

► To Login

1. Follow the steps “To access the web” on page 99.
2. After you enter the IP Address of the Web Server, the Login screen displays (shown right).
3. Enter a Directory Number in the User DN field.
4. Enter your Password.
5. Press the Login soft key.

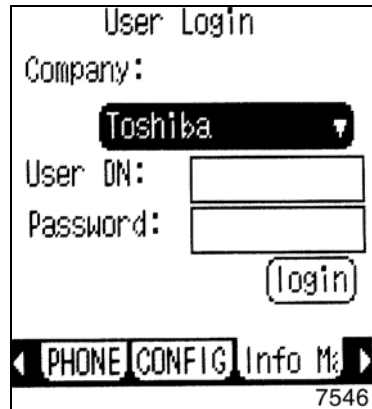

Note The application options screen displays (shown right). Press the soft keys to select an application.

You also have an option to cycle through all the applications (Cycle), an option to configure the application, or an option to logout.

You get logged out of the system when you select Logout by pressing the softkey on the right of it and the Login screen displays.

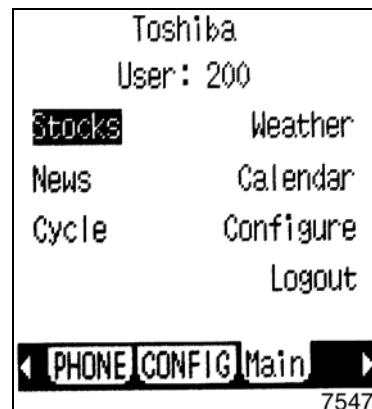

Options Screen

Stocks

- From the Options screen, press the Stocks soft key to view a list of stock quotes.

Note To add or remove stock quotes, see [“Adding and Removing Stock Quotes, Company News and Weather”](#) on page 108.

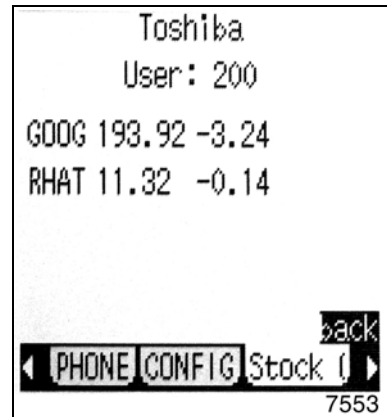

Weather

1. From the Options screen, press the Weather soft key to check the weather of a location.

The Weather screen showing the cities displays (shown right).

2. Select a city by using the corresponding softkeys.

The weather for that city displays (shown below).



Note To add or remove Weather, see [“Adding and Removing Stock Quotes, Company News and Weather”](#) on page 108.

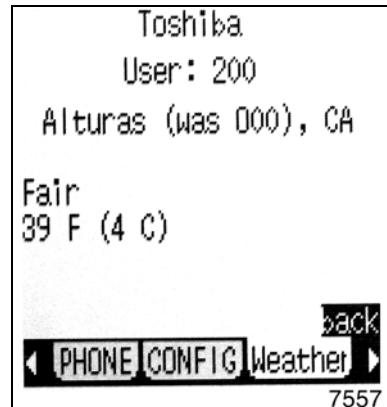

News

1. From the Options screen, press the News soft key to view company news headlines.
2. To view details pertaining to an item, press the soft key next to the news item.

For example, you can either press the soft key next to “01-20: See’s Candy Sale” or the soft key next to 01-20: Hawaii Trip.” The corresponding story displays (shown below).



3. Press the next or back soft keys to view other news items.

Note To add or remove News items, see [“Adding and Removing Stock Quotes, Company News and Weather”](#) on page 108.



Calendar

You can select Calendar to view your calendar on a Microsoft Exchange Server.

1. From the Options screen, select Calendar. The calendar screen displays (shown right).
2. Select the Login to Outlook softkey.

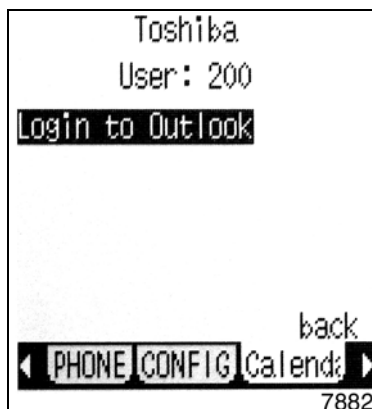

The Calendar Login screen displays (shown right).

3. Enter your Microsoft Outlook Username and Password.

Notes

- Use the right softkeys corresponding to either the Username or Password.
 - Use the dial pad letters to enter the Username and Password.
4. Select the right softkey corresponding to Cache to check or uncheck Cache.

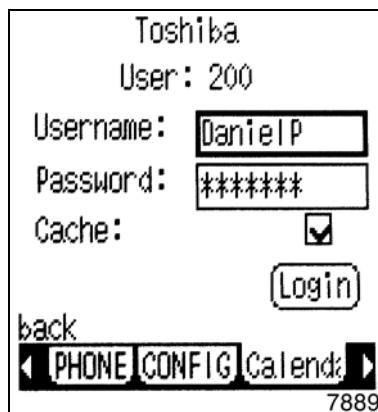

Note Check Cache for the database to remember your Username and Password.

5. Select the Login softkey on the right.
Your meetings screen displays (shown below).

For details on an item, select the corresponding softkey next to the date on the meeting screen. The Meeting details display (shown below right).

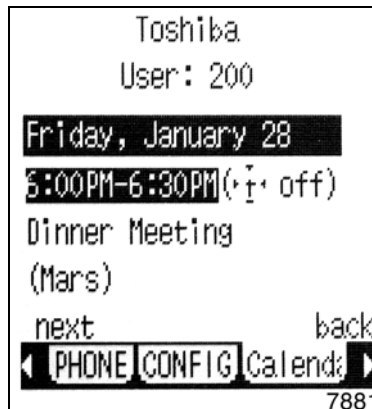

Meetings Screen

► **For the Telephone to notify you of a Meeting**

1. Select the softkey next to the meeting time on the Meetings screen.

The Meeting Notification screen displays (shown right).

2. Use the corresponding right softkey to select the Notify time box. This is the time (in minutes) for the telephone to notify you before a meeting.
3. Use the dial pad to enter the time.
For example: You will be notified by the telephone five minutes before the dinner meeting in the screen shown on right.
4. Click the Enter Navigation button
5. Click the Enable softkey on the right.



► **To Cancel/Update/change the time of a meeting**

1. Select the meeting item from the Meetings screen.
2. Select the Cancel softkey.
...or just change the time, then select the Update softkey.

Cycle

Select Cycle to cycle through the web applications.

...or

1. From the Options screen, press the Configure soft key.
2. Press Properties soft key.
3. Press the Auto soft key. The cycle screen displays (shown right).
4. Enter the Start time. This is the number of seconds after which the Options screen should Auto cycle.
5. Enter the Cycle time. This is the cycle time between the applications.
6. Press the Submit soft key.

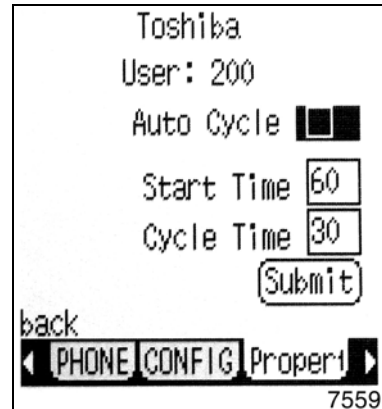

Configure

This screen enables you to configure web application properties or to change the application content.

- **Properties** – By pressing the Properties soft key, you can access the Auto cycle screen shown above.
- **Content** – By pressing the Content soft key, you can access Stock Quotes, News and Weather.



➤ **Adding and Removing Stock Quotes, Company News and Weather**

1. From Configure, select Content.
The Add/Remove Stock Quote screen displays (shown right).

Press the next soft key to Add/Remove Weather.

2. Select the appropriate softkey to add or remove a stock quote.



Stock Quote

When you select the add or remove buttons in the above screen, the following screens display depending on the selection.

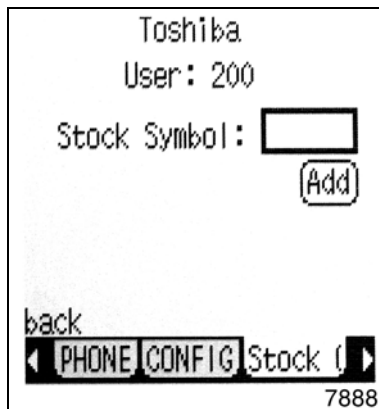

Add Stock Quote

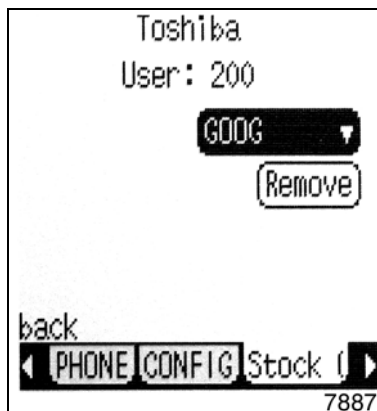

Remove Stock Quote

Company News

You must have administrative privileges to add or remove news stories.

- From the Options screen, select Configure > Content > Next. Select Add/Remove. Depending on your selection, one of the screens below displays.

Add Company News

Remove Company News

➤ To Change or enter a new date on the Add Company News screen

1. Press the Left soft key corresponding to the Month.
2. Use the navigation ▼ arrow button to select the month.
3. Press Enter (Oval Navigation center button).
4. Press the navigation ► arrow button to move to the Day/Year.
5. Use the navigation ▼ arrow button to select the day/year.

► To enter the Headline/Story

1. Press the right softkey corresponding to Headline.
2. Press # to enter the Alpha mode.
3. Use the letters on the dial pad to enter the headline.

**Weather**

You must have administrative privileges to add or remove Weather.

1. From the Options screen, press the Configure soft key.
2. Press the Content soft key.
The first screen is Stock Quote.
3. Press the next soft key.
The Add/Remove Company News and Weather screen displays.
4. Press the corresponding Add or Remove softkey.



► **To add a Weather destination**

1. Complete steps 1~3 above.
2. Press the Add soft key.
3. Select a State (shown right). Use the ▲ or ▼ arrows to scroll to the appropriate location.
4. Press the soft key next to the location.
5. Press the Find soft key.
6. Press the soft key next to the location that displays.



7. Select the city or location you wish to see by using the navigational buttons.
8. Press the Enter button on the selection.
9. Press the Add soft key to add the city for the weather you want displayed (shown right).



► To remove a Weather destination

1. From the Options screen, press the Configure soft key.
2. Press the Content soft key.
The first screen is Stock Quote.
3. Press the next soft key.
4. Press the remove soft key.
5. Select the city or location by using the navigational buttons.
6. Press the Enter button on the selection.
7. Press the Remove soft key.

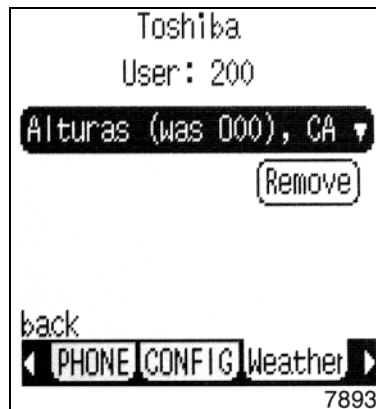

DKT3014/3214-SDL LCD Features 6

This chapter shows how to use the DKT3214-SDL (shown below) large screen directory display and individual name searches.

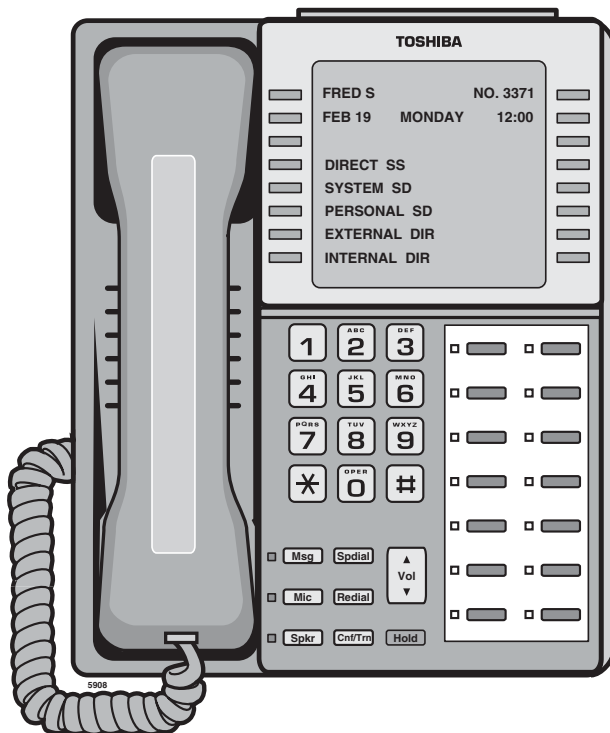

DKT3214-SDL Telephone

Directory and Speed Dial Listings

The directory menu (idle state) is shown below.

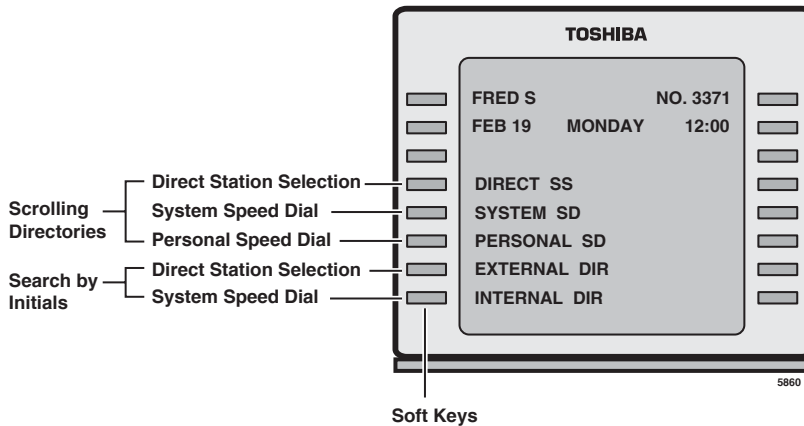

Direct Station Selection

This option displays all named stations in alphabetical order.

1. Press the **DIRECT SS** Soft Key to view the first screen.
2. To view the following page, press the **MORE** Soft Key; press **PREVIOUS** to page back.
3. To select someone from the list, press the Soft Key next to their name. The system calls that number.

FRED J	NO. 3371
MAR 18	MONDAY 01:35
BOB T	
DON U	
CAROL F	FRED M
CUST SERV	GRAY W
PREVIOUS	MORE
EXIT	

CALLING
3200

System Speed Dial and Personal Speed Dial

Using System Speed Dial and Personal Speed Dial is very similar to using Direct Station Selection, described above.

1. Press the Soft Key next to **SYSTEM SD** or **PERSONAL SD** to view the first screen.
2. To view the following pages, press the **MORE** Soft Key; press **PREVIOUS** to page back.
3. To select someone from the list, press the Soft Key next to their name. The system calls that number and displays its directory information.

Internal Directory and External Directory

External Directory enables you to search the System Speed Dial Numbers alphabetically (typically, external destinations). Internal Directory enables you to search all of the internal name extensions alphabetically. This saves time since you do not have to step through the lists screen-by-screen.

See [Table 13 on page 117](#) for instructions on entering letters, numbers and punctuation from the dial pad.

1. Press the **INTERNAL DIR** or **EXTERNAL DIR** Soft Key to view the first screen.

FRED J	NO. 3371
INPUT THE NAME?	
EXIT	FIND

2. Begin by entering the name (see [Table 13 on page 117](#)) and pressing the **FIND** Soft Key.

FRED J	NO. 3371
B	
LEFT	RIGHT
EXIT	FIND

DKT3014/3214-SDL LCD Features

Directory and Speed Dial Listings

If you entered “B,” all names beginning with “B” are listed. You can press the **MORE** Soft Keys to view adjacent pages.

3. To select someone from the list, press the Soft Key next to the name. The directory information displays.

FRED J	NO. 3371
B	
BAKER G	BALL F
BAWLER S	BRETON I
PREVIOUS	MORE
EXIT	FIND

4. Press the Soft Key next to the person or dept. you wish to call. The system calls and displays the directory information.
5. Press any key to return to the idle screen...or, from the directory listing screen, press **EXIT** to return to idle.

FRED J	NO. 3371
	00:00:01
	CONFERENCE
ABR	
PAGE	

Storing Personal Speed Dial Names

You can store names with Personal Speed Dial numbers. These names will display as Soft Keys, that can be used for dialing with the Personal SD directory on the IPT2008-SDL telephone.



Note Speed Dial bins (locations) must be assigned to your IPT2008-SDL telephone by your System Administrator before you can store names. Your System Administrator can also associate names with Station Speed Dial numbers.

► To assign Station Speed Dial names

1. Enter User Programming Mode by dialing #9876 or, press Program.
2. Press Spdial. “SPEED DIAL MODE” displays on the LCD.
3. Enter a Speed Dial location number (100~199, depending on system programming).

4. Enter the telephone number to be stored. If you normally use a dial line access code (such as 9) and/or an area code, enter the codes before the telephone number.



Example:
 Press the  for "A."
 Press the  again for "B," etc.

Refer to the table for other characters.

5. Press Spkr, then input the name that will appear in the Personal SD directory (nine characters max).

You can enter alphanumeric characters from the dial pad (shown right and in [Table 13](#)).

- To move one character to the right, press the **RIGHT** Soft Key. To add a space, press the **RIGHT** Soft Key twice.
- To backspace (delete previous character), press the **LEFT** Soft Key.
- To cycle back to the first letter, continue pressing the **LEFT** Soft Key.

6. Press Spdial. The Speed Dial name is now programmed.

7. Go off hook. The IPT exits User Programming Mode.

8. Test the Personal SD entry by pressing the **Personal SD** Soft Key. Look for the name in the entry and press the Soft Key associated with that name.

Table 13 Dial Pad Alphanumeric Characters

Dial Pad Buttons	Number of times to press the dial pad button				
	1	2	3	4	5
1	-	.	:	,	1
2	A	B	C	'	2
3	D	E	F	!	3
4	G	H	I	&	4
5	J	K	L	*	5
6	M	N	O	#	6
7	P	Q	R	S	7
8	T	U	V	?	8
9	W	X	Y	Z	9
0	()	&	/	0

This page is intentionally left blank.

This chapter contains user information for FeatureFlex features when connected to a Strata CIX system. FeatureFlex features are optional and do not come standard with every telephone or Strata CIX system.

Refer to the Strata CIX My Phone Manager User Guide for features that require My Phone Manager software. Programming information for FeatureFlex features can be found in the *Strata CIX Programming Manual Volume 3 – Application Implementation*.

Important!

- Refer to the Strata CIX My Phone Manager User Guide to edit Alarm Clock, Call Monitor, Return Call and Call Screen using My Phone Manager software.
- To see how these features interact with other FeatureFlex features, refer to [“FeatureFlex Interactions” on page 125](#).

Alarm Clock

This feature enables you to set reminders/notifications on your telephone. At the time set your telephone LCD displays Alarm, the LED will blink Red and the telephone will ring.

Important!

- Your System Administrator must assign an Alarm Clock Flexible button on your telephone for this feature to work.
- The clock follows your Voice Mail clock.
- The telephone will not ring at the alarm setting if the phone is not idle and it has been programmed to Call Forward.

► To set an alarm clock notification

1. Press the Alarm Clock flexible button.
The system will announce the current alarm setting.
2. When the system prompts you to enter the hour, enter the hour of day you wish to set your alarm.
3. Enter the minute when the system prompts you to do so.
4. Press 1 for A.M. and 2 for P.M.
5. The Alarm button now displays a green light.

Voice Mail Call Monitor

Using the flexible Call Monitor button on your telephone, you can listen to a caller while the caller records a message in your voice mailbox. You can also answer the call while the message is being recorded. When the call is picked up the message recording stops.

► To enable and disable Call Monitor on your telephone

1. While on hook, press the idle Call Monitor button. You hear the voice prompt “Enter your security code.”
2. Enter your voicemail password (maximum of 16 digits; numbers 0~9). LCD displays “Talk to xxx,” where xxx = voice mail port DN.
3. Press #.

You’ll hear the voice prompt “Call Monitor Enabled.” The LCD now displays “Logged into VM” briefly and then displays the original information.

The Call Monitor LED light turns solid green.

- Press the Call Monitor button to disable Call Monitor. The Call Monitor LED will turn off.

► To monitor a call using Call Monitor

1. The flashing green Call Monitor button indicates that a message is being recorded in voice mail.
2. Using the speakerphone, press the Call Monitor button. The Call Monitor LED flashes red. You can hear the caller leaving the message, but the caller cannot hear you.

The LCD displays “Monitoring VM xxx,” where xxx = Caller’s DN.

3. To talk to the caller, press the Call Monitor button again (The LED changes from flashing Red to solid Green).

The LCD display indicates the extension or line connection.

Voice Mail - Return Call

This feature works like the Boomerang feature. When you have many voice messages in your mailbox and while you're listening to them you can reply to some or all of the messages via Voice Mail. Then pressing the Return Call button takes you back to the message where you stopped. It works like placing a bookmark in a book.

► To use Return Call

Important! *For this feature to work, the Return Call flexible button must be programmed in Program 205 by your System Administrator. This flexible button must not be assigned to any other feature.*

1. Log in to your Mailbox.
2. Press 1 to play your messages.
If you decide to return the call, press 6 on your dial pad or the Reply soft key.
3. Then, press 1 to reply to a mailbox
...or press 2 to return the Call.

The Voice Mail calls the caller and transfers you to the caller.

Note When you press 2, the "Return Call" flexible button (turns red) gets activated and you begin to hear the message "I will return your place in the mailbox...."

4. Talk or leave a message for the caller, then Hang up.
The Voice Mail takes you back to where you stopped.
5. If you decide to hang up, press Spkr to disconnect voice mail.

Screen Call

This is a FeatureFlex feature and is available only with the Strata CIX. Screen Call enables you to create a list using the My Phone Manager software under FeatureFlex > Screen Call > Edit. This list will either send a call directly to Voice Mail or will make your telephone ring.

Important!

- If you do not enter any telephone numbers in the list, then Screen Call permits your voice mail to examine calls that are intended for your telephone, and handle them based on the Caller's Name.

When you haven't created the list in My Phone Manager; or you created a list of "Send to Voice Mail" numbers in My Phone Manager, four handling options are available: Send the call to the telephone, send the call to voice mail, transfer the call to a station with an announcement, and transfer the call to a station without an announcement.

► **For an incoming call**

1. The voice mail prompts the caller to say his name.
2. The caller mentions his name.

Voice mail then transfers the call to the extension. The caller is made to hold while voicemail tries the extension.

3. The telephone rings, voice mail announces:
"You have a call from
To accept the call, press 1
To reject the call, press 2 and hang up
To transfer with announcement, press 3
To transfer without announcement, press 4"

Notes

- If you press 1, you can talk to the caller.
- If you press 2, voice mail will transfer this call to your mailbox.
- If you press 3, it asks you to enter the extension number and then record an announcement. After you record the announcement, you have the following options:
To review, press 1
To re-record, press 2
To append, press 3

To cancel recording, press 4

To save, press 9

Pressing 9 saves your announcement, then voicemail transfers the call to the extension you entered. Voice mail plays your announcement to the caller and the transferred destination starts ringing.

If you press 4, you can enter the extension you want to transfer the call and voice mail will transfer it to the destination.

One Number Access

This feature requires My Phone Manager, refer to the Strata CIX My Phone Manager User Guide for My Phone Manger user instructions.

Hot Desk

Hot Desk enables a user to use a shared office telephone with his/her own directory number. In order to use this FeatureFlex application, the feature must first be assigned to the extension by your System Administrator using either eManager or the My Phone Manager program.

► To log into the Hot Desk phone

1. Dial the Pilot number from PDN on the phone (get this number from you System Administrator).
2. The phone prompts you to enter the new extension number.
3. Press #
4. Example: Enter 4001#
5. The system prompts, "You entered 4001, if this is correct, press 1." You are now logged in.

► To return the Hot Desk phone or to log out

1. Dial the Pilot number from PDN on the phone.
 2. Press * to cancel the assignment.
- OR
1. Press the feature access button assigned for Hot Desk.
 2. Press * to cancel the assignment.

FeatureFlex Interactions

The following table shows how the FeatureFlex Applications interact with other FeatureFlex Applications and some CIX features.

	Alarm Clock	Screen Call	Call Return	Call Monitor	One Number Access	Hot Desk
Alarm Clock		OK	OK	OK	OK	OK
Screen Call	OK		OK	OK	See Note 1	OK
Call Return	OK	OK		OK	OK	OK
Call Monitor	OK	OK	OK		OK	OK
One Number Access	OK	See Note 1	OK	OK		OK
Hot Desk	OK	OK	OK	OK	OK	
Phantom DN	No FeatureFlex features can be assigned to a Phantom DN.					
Conference/Transfer	OK	See Note 2	OK	OK	See Note 2	OK
Multiple Appearances	OK	OK	OK	See Note 3	OK	OK
All Call Forwarding	OK	See Note 4.	OK	OK	See Note 4.	See Note 5.
Busy Forwarding	OK	See Note 4.	OK	OK	See Note 4.	OK
Auto Attendant	OK	See Note 6.	See Note 6.	See Note 6.	See Note 6.	OK

Notes:

1. Call Screen and One Number Access (ONA) should not be assigned to the same phone. If a phone has ONA registered, and one of its destinations has Screen Call registered, then when a call is routed by ONA to that destination, the call simply rings the phone instead of screening it.
2. If the caller has another call on hold, Screen Call and One Number Access will not operate. The caller is sent to voice mail.
3. The monitoring call can be transferred by putting it on hold at one phone and then retrieving it from a secondary appearance at another phone. When this happens, the monitoring function cannot be controlled by the phone that retrieved the call. The only action available is to hang up.
4. If a call is forwarded to a phone that has Call Screening or ONA turned on, and that phone is itself forwarded to another phone, then the FeatureFlex feature will not turn on.
5. If a Hot Desk user does not login to a phone, all calls will be routed to user's mail box regardless of Call Forwarding setting.
6. If a call is transferred from Auto Attendant, FeatureFlex feature is not activated.

User programming enables you to change your telephone's layout/registration and other settings. With user programming you can re-define Flexible Buttons to perform other functions.

- Enter numbers in your personal Speed Dial list
- Program One Touch and Flexible Buttons
- Register Call Forward assignments for easy use (max. of four buttons per telephone)
- Assign Message Waiting Keys
- Assign the background music (BGM) source to be played over the telephone's speaker

Note User Programming applies to LCD telephones only.

Programming Feature Buttons

Digital telephone users can use the programming mode for customizing their Toshiba telephones without the aid of an Administrator or Service Technician. The User Programming mode is accessed with a Program button assigned to a Flexible Button or through an access code. User Programming enables users to customize these features:

- **Flexible Buttons** – Toshiba telephones have 10, 14, or 20 Flexible Buttons to which the user can assign any one of approximately 50 different features (DND, ACB, Release, etc.). Once assigned to a button, the feature is accessed by pressing that button. Some of the types of feature buttons that users can set on their telephones include:

User Programming

Flexible Button Codes

- **Call Forward** – Users can set the Call Forward (CF) destination and CF-No Answer timer for the CF buttons.
- **One Touch** – Users can set speed dial and custom feature access code sequences for One Touch buttons.
- **Background Music** – Users can select Quiet Tone or the music source (up to 15) that will play on their telephone’s speaker when they activate the BGM button.

Note Directory number and external line buttons cannot be added or deleted, but their ring tones can be individually changed.

In addition to the Programming Mode, an advanced programming function enables your System Administrator to individually turn On/Off the telephone’s beep tone, handset call waiting tone, and microphone background noise cancellation option. This mode enables LCD contrast adjustment and testing the IPT3014 LCD screen.

User Programming Mode

- To enter User Programming Mode, press the Program button
...or dial #9876. “USER PROG MODE” appears on your LCD. The Program LED is steady green.
- To exit User Program Mode, press Program
... or go off- and on-hook press #9876.

Note A IPT equipped with a headset adapter ignores the hookswitch. It can only exit User Programming by timing out (approximately 15 seconds).

Flexible Button Codes

Flexible buttons are the unassigned buttons on your keypad that can be used to store features. The number of available Flexible Buttons depends on your telephone model and how the buttons are preassigned by the System Administrator. See [pages 4 and 11](#) for the Flexible Button locations.

The following steps enable you to program features onto Flexible Buttons for one-touch feature access.

Setting/Changing a Flexible Button's Function

1. Press #9876 to enter User Programming Mode.
2. Press Hold.
3. Press the Flexible Button to set or change.
4. Enter the Flexible Button Code (see [Table 14](#)), plus any optional parameters.
5. Press the same Flexible Button (flashing) to save the setting. "DATA PROGRAMMED" appears on your LCD.

Table 14 Flexible Button Codes

Feature	Code
Account Code	660
Automatic Busy Redial - On	150
Automatic Callback	160
Background Music	530
Call Forward (CF) - Any Calls	
All Call	340
Busy	350
No Answer	360
Busy No Answer	370
CF - External (Outside) Calls	
All Call	380
Busy	390
No Answer	400
Busy No Answer	420
Call Park Orbit	170
Call Pickup	
Incoming - Group Pickup	430
Incoming - Directed Extension Pickup	440
Incoming - Directed Group Pickup	450
Incoming - Directed Extension Pickup	460
On hold - Local Retrieve	490
On hold - Remote Retrieve	500
On hold - Outside Line Retrieve	480
On hold - Directed Extension Retrieve	510
On hold and Incoming	520
Incoming - Any External Call	470

Feature	Code
Caller ID	580
Cancel	290
Do Not Disturb (On/Off)	180
Door Lock Cancel	540
DSS Button	610
Flash - Short	200
Flash - Long	210
Microphone Cut-off	840
One Touch Button	570
Paging	
Page All Groups	220
Page Individual Groups	230
Emerg. Page - Individ. Group	250
Emerg. Page - All Groups	240
Answer Page - All Groups	590
Phantom Extension Message Waiting	560
Privacy	320
Privacy Release	330
Night Transfer	600
Record to VM	630
Pause/Resume recording	640
Release Button	270
Release/Answer	280
Split	860
Speed Dial	260
User Programming Mode	650

One Touch Buttons

One Touch buttons can be used for storing frequently used features or dialed numbers, such as Speed Dial numbers (use Speed Dial Codes to store additional numbers). One-touch buttons can be preassigned to your telephone – your System Administrator can help you identify them.

If you do not have a One Touch button, but you have an available Flexible button, you can convert the Flexible button to a One Touch button. Perform the procedure called [“Setting/Changing a Flexible Button’s Function” on page 129](#) (in Step 4, enter the access code for One Touch button). Once you have created a One Touch button, you can change the function by using the following procedure.

Changing a One Touch Button

1. Press #9876 to enter User Programming Mode.
2. Press the One Touch button to be set.
3. Enter the digits or special buttons for the function to be dialed. You can include the following in the dial string:
 - Dial pad digits 0~9. To program special characters, see [Table 15](#).
 - A maximum of 32 characters.
 - Station and System Speed Dial index (or bin) numbers can be entered. The Speed Dial index number will automatically dial out on the extension or Line programmed on the One Touch button with the associated Speed Dial index number.
 - Function buttons, except One Touch or a Program button.
 - Handset hooking (on-hook/off-hook) cannot be recorded.
4. Press the One Touch button to save the entry.

We suggest writing the name or number of the One Touch button on your button strip.

Table 15 Special Characters

Entry	Meaning
* + Hold	Indicates “stop.” The One Touch button blinks rapidly and stops the delivery of the remaining digits in the string until it is pressed again. Multiple “stops” can be programmed into one string.
* (1~9)	Pause (1~9) seconds. If you need to pause longer than nine seconds, enter additional pause escape sequences. For example, to insert a 17-second pause, enter *9*8. The display of a pause in the Speed Dial Number shows a “P” without specifying the duration. In this example, you would see “PP.”
* *	*
* #	#

Example of Special Character Usage

To create a One Touch for Park and Page under one button, program the following sequence under the One Touch button.

➤ CNF #33***HOLD FB1 #30

CNF – puts the caller on hold and gets new dial tone.

#33 – code to park call

* * – this special character outputs a single * which will select an available orbit and display the selected orbit on the phone.

*HOLD – This special character is a Stop. The dial string pauses and enables the user to view the selected orbit on the display. The dial string will restart from this point when the One Touch button is pressed again.

FB1 – gets new dial tone on the PDN

#30 – code for All Call Page which allows the user to page the location of the orbited call.

To Use a One Touch Button

➤ Press the One Touch button.

Setting/Changing a Personal Speed Dial Code

See “Storing a System/Station Speed Dial Number” on page 66.

Feature Codes

Feature Access Codes are entered as a sequence on your telephone to use a particular feature. For an example of Call Forward, see “[Call Forward Examples](#)” on page 43.

Table 16 Feature Access Codes

Feature	Feature Access Code Sequences ¹
Account Code (while on a call)	Cnf/Trn + #46, dial account code digits
Attendant Console	Ext. button + 0
Automatic Busy Redial - On	Cnf/Trn + #441, hang up
Automatic Busy Redial - Off	Ext. button + #442
Automatic Callback (while on a call)	4 when you hear busy tone
Automatic Callback Cancel	Ext. button + #431
Background Music	
Telephone Speaker On	Ext. button + #490 + music source no. (1~15) + #
Telephone Speaker Off	Ext. button + #491 + Spkr
External Speaker On	Ext. button + #492 + music source no. (1~15) + #
External Speaker Off	Ext. button + #493 + Spkr
Call Forward - See Table 2 on page 43.	
Call Park	
Activate (while on a call)	Cnf/Trn + #33 + Orbit Number (7000~7019) or your Ext. No.
Retrieve (while on a call)	Ext. button + #32 + Orbit Number (7000~7019) or your Ext. No.
Call Pickup	
Directed DN pickup of ringing or held calls.	Ext. button + #5#6 + Ext. No
Directed DN pickup of ringing, held or parked calls.	Ext. button + #5#29 + Ext. No. to be picked up
Incoming - Group Pickup	Ext. button + #5#34 + Group Number to be picked up
Incoming - Directed Extension Pickup	Ext. button + #5#5 + Primary Ext. No to be picked up
Incoming - Directed Group Pickup	Ext. button + #5#32 + Group Number to be picked up
Incoming - Directed Extension Pickup	Ext. button + #5#22 + Ext. Number

Table 16 Feature Access Codes (continued)

Feature	Feature Access Code Sequences ¹
All Call Page, Group Page and/or External Page Pickup of page	Ext. button + #5#36 + Page Zone No. (01~08)
	#5#5 + Ext. No. of another phone being paged.
Call Pickup for calls on Hold	
Local Pickup (call held on this phone)	Ext. button + #5#71
Remote Pickup (pickup another extension)	Ext. button + #5#72 + Primary Ext. No.
Pickup an Outside Line on Hold	Ext. button + #5#73 + Outside Line on hold (001~128)
Pickup a an on Hold	Ext. button + #5#74 + Ext. No. on hold
Conferencing - Three Way	#494
Dialing Special Characters from a Rotary Phone	
Simulate Dialing *	Dial 441
Simulate Dialing #	Dial 440
DISA Security Code - Change	Ext. button + #658 + old Security Code (1~15 digits) + # + new Security Code (1~15 digits) + #
Distinctive Ringing - See “Distinctive Ringing” on page 53.	
Do Not Disturb	
Local - On	Ext. button + #6091
Local - Off	Ext. button + #6092
Remote - On	Ext. button + #6191 + ext. no. of the phone where DND will be set + Pass Code Number + #
Remote - Off	Ext. button + #6192 + ext. no. of the phone where DND will be set + Pass Code Number + #
Door Lock Control	Ext. button + #12 + Door Lock Number
Door Phone Calling	Ext. button + #15 + Door Phone No. (01~24, depending on system size)
Emergency Call	Ext. button + #911
Flash - Short	Ext. button + #450
Flash - Long	Ext. button + #451
LCD Language (Change)	Ext. button + #495 + Language No.
LCR (Outgoing Call)	Ext. button + 9
Message Waiting (MW)	

User Programming

Feature Codes

Table 16 Feature Access Codes (continued)

Feature	Feature Access Code Sequences¹
Manually turn off MW LED	Ext. button + #409
Retrieve a received MW	Ext. button + #408
Activate MW at another Station without Ringing	#63 + Ext. no. (where you want to light the MW LED)
Cancel MW at another Station without Ringing	#64 + Ext. no. (where you want to turn off the MW LED)
Messaging - Advisory	
Advisory Message - Activation	Ext. or Phantom Ext. button + #411 + Message No. (see table in “Advisory Messages” on page 34). Hang up.
Advisory Message - Cancellation	Ext. or Phantom Ext. button + #412. Hang up.
Network Access Code (Private Network)	8 + Private Network No.
Night Ring Answer	Ext. button + #5#39
Off-hook Call Announce or Busy Override	Voice First: 2; Tone First: 1, 21, 12, or 5, depending on programming for your phone.
Override	
Busy, Do Not Disturb	After reaching a busy or DND station, press 2.
Executive	After reaching a busy station, press 3
Paging	
Page All Groups	Ext. button + #30
Page Individual Groups	Ext. button + #31 + Page Zone No. (01~08)
Emergency Page - Individual Group	Ext. button + #38 + Group Number
Emergency Page - All Groups	Ext. button + #37
Answer for External Group Page	Ext. button + #5#36 + Page Zone No. (01~08)
Repeat Last Number Dialed	Ext. button + *0

Table 16 Feature Access Codes (continued)

Feature	Feature Access Code Sequences ¹
Speed Dial (Storing an SD number)	
Station ²	#66 + nnn + Phone No. ³ + # nnn = 100~199 SD bin numbers
System ²	#66 + nnn + Phone No. ³ + # nnn = 200~999 SD bin numbers
Speed Dial (Dialing a stored SD number)	
Station ²	Spdial ⁴ + nnn nnn = 100~199 Station SD bin numbers
System ²	Spdial ⁴ + nnn nnn = 200~999 System SD bin numbers
Start Application	#18
Travelling Class Override	
Enter Code	#471, then dial number (enter LCR code if required)
Change Code	#69 + Index Number + old Code + # + new Code + #
Uniform Call Distribution	
Login from Agent Station	#6061
Logout from Agent Station	#6062
Login to Agent Station—another Station	#6161
Logout to Agent Station—another Station	#6162
User Programming Mode	#9876
Voice Mail (VM)	
Direct Transfer to Voice Mail	While on a call, press Cnf/Trn + #407. Dial VM mailbox number (usually Ext. Number) + #.
Volume Control - Beep	With handset off-hook, press #6101. Press Vol ▲ or ▼.
Volume Control - Ringing	With handset on-hook, press #6102. Press Vol ▲ or ▼.

1. If you have “hot dialing,” you do not need to press Ext. button as part of the sequence.
2. Stations must be assigned/enabled SD capabilities in system programming by an Administrator in Program 200-30 (System SD) and Program 200-35 (Station SD).
3. Refer to [Table 7 on page 67](#) to see how to enter * and # into a speed dial number.
4. If your telephone does not have a Spdial button, press the * button, then dial the three digit Speed Dial bin number (nnn).

LED Indicator Details

Each line and feature button has a LED next to it which indicates the status of the line or feature associated with the button. Line LEDs light red or green and flash at varying rates to indicate call status (see [Table 17](#)).

Table 17 LED Indicators

LED	Your Station (Green)	Other Station (Red)
	Interval Rates	
Extension In-Use (access outside line)	2 seconds On, 1/8 second Off — 1/8 second On/Off	steady
Incoming Call (while ringing)	1 second on at 10 pulses/ second —1 second Off	one second On/Off
Hold (outside line) If using Pooled Line Grp, the hold indication is only at the station that places the call on hold.	4 pulses/second for 1/8 second On/Off	1/2 second On/Off
Hold – Consultation (during consultation/transfer to another station)	10 pulses/second	steady
Hold – Exclusive (outside line)	10 pulses/second	steady
Hold – Recall (when held call recalls your idle station)	1 second at 2 pulses/second, 1 second at 10 pulses/second	flashes
Hold – Exclusive Recall	1 second at 2 pulses/second, 1 second at 10 pulses/second	steady
Internal Call (while station ringing)	Your extension button flashes 10 pulses/second—1 second Off	[SDN] red flashing or green ringing
Busy Station Transfer (outside call transferred to your busy station from a designated station or AA)	4 pulses/second, 1/8 second On/Off	3/4 second on, 1/8 second Off
After disconnecting first call...	10 pulses/second	2 pulses/second
Conference	10 pulses/second	steady

This chapter provides an overview of the following two optional units and describes the features, buttons and associated LEDs. It describes the various models for the following two types of units.

- **Digital Add-on Module (DADM)** – adds 20 line/feature buttons to digital telephones. Up to two DADMs can be connected to a telephone.
- **Direct Station Selection (DSS) Console** – adds 60 line/feature buttons to a digital telephone. Available for system operators who do not have an attendant console.
- **IP Add-on Module (IADM)** – adds 20 line/feature buttons to the IPTs. Up to two IADMs can be connected to an IPT.
- **IP Direct Station Selection (IDSS) Console** – operates alongside an IP telephone and has 60 line/feature buttons. Up to three consoles can operate with one IP telephone.

Note The CIX can support up to two IADM2020, but it cannot support the IDSS2060.

ADM

Digital add-on Modules (DADM) can be connected to IPT and 3000/3200-series telephones to provide additional buttons. Certain models are not interchangeable.

The DADM3120/3220 (shown below right) works with the DKT3000/3200-series telephones and the IPT1020-SD. The DADM3120/3220 works with 3000/3200-series telephones only.

The IP add-on Module (IADM) offers all the same features of the DADM3120/3220.

Buttons and LEDs

The DADM31 20/3220 provides 20 feature buttons to their respective telephones. These flexible feature buttons can be assigned as CO line, Directory Number, DSS, One Touch Speed Dial or any other flexible feature.

Up to two DADMs can be attached to a telephone to provide 40 buttons to supplement the telephone's 10 or 20 buttons.

Each DSS button and Line button has an LED that provides a status of the outside line or station assigned to it. The DSS button acts like a speed dial button to a specific extension.

- A station or line shows steady red when in use by others; green when in use by the DADM.
- A DSS LED will flash red while making a call and turn intermittently green once connected.
- An outside Line LED is green when the outside line is in use by the DADM console user. It is red if it is in use by another telephone user.

Note Button numbers in the figure to the right are examples only.

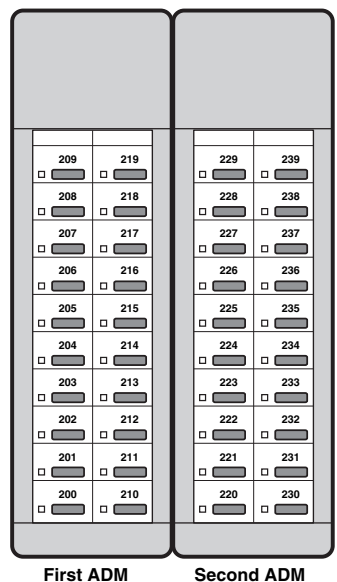

DSS Console

The Direct Station Selection (DSS) console operates alongside an IP or digital telephone to provide 60 additional buttons. The DKT3000/3200-series telephones require a 3000/3200-series DSS. A DDSS3060/3260 example is shown right.

Note The IP telephones do not support a DSS console when connected to a Strata CTX running R2.22 or older software.

The 60 flexible feature buttons can be assigned as CO line, extension, DSS, One Touch Speed Dial or any other flexible feature.

The DDSS3060/3260 console uses dual red and green LEDs to show call and feature status.

Note Button numbers in the above figure are examples only.

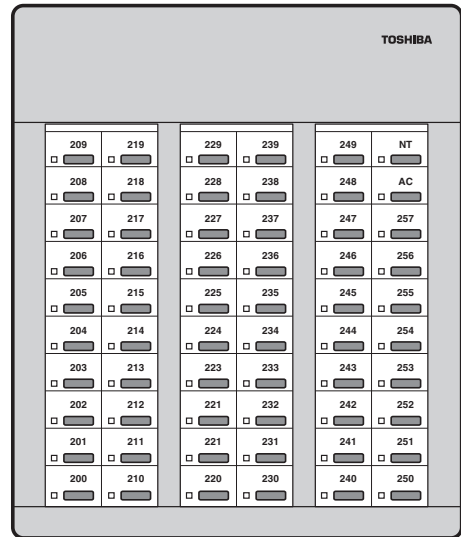

DSS Buttons

DSS buttons can appear on both the ADM and DSS Console. Each DSS button is associated with a particular station in your telephone system. DSS buttons can transfer an outside call to the associated station or make a direct call to the associated station.

The DSS LED lights steady red when the station associated with the DSS button is ringing, busy on a call, or when the associated station is idle, but all appearances of the station's extensions are busy or in-use by other stations. When the associated DSS button is in the Do Not Disturb mode, the LED blinks red at a slow rate.

DSS buttons cannot call station Phantom extension numbers, Distributed Hunt Group Directory Numbers, or ACD Groups. DSS buttons may be configured as One Touch Buttons that may be programmed to call these destinations.

The LED colors described in this section apply to the DADM3020/3220 and DDSS3060/3260. Described Flash conditions apply to all DSS console models and the DADM.

Calling a Station

- To call a station's extension from either a DSS console or a DADM, press the DSS associated with the station.

A station call with a DSS button can be made on-hook or off-hook, and with Voice First or Tone signaling. After pressing the button, treat the call like any other station call made from a digital telephone.

DSS LEDs indicate whether the associated station is idle or busy. The LED is steady red if the station is busy or ringing, and is not lit if idle. If all the station's PDN buttons are being used by other stations, the DSS LED of the station is lit steady red, but the station may be idle. If the station is in the Do Not Disturb mode, its DSS LED lights blinking red.

Transferring to an Idle Station

You can transfer internal or outside calls to an idle station from either a DSS console or a DADM.

➤ To transfer a call to an idle station

1. Press the DSS button corresponding to the station to be called.

The call is placed automatically on hold. The Line or extension LED flashes green at double the on-hold rate, and the DSS LED flashes green. You hear a single ring tone. (If using the Tone signaling mode, you hear successive ring tones.)

2. Announce the call.

With Tone signaling, you would have to wait for the called station to answer before announcing the call.

3. Hang up.

The call rings the called station when you hang up. While the called station is ringing, the DSS LED is steady red, and the Line LED flashes green at the on-hold rate or if on an extension button, it goes idle.

When the called station answers the call, the DSS LED stays steady red, and the Line LED becomes steady red.

4. If the station does not answer before a period set in system programming, the call recalls your station.

Call Transfer with Camp-on

You can transfer a call to a busy station from either a DSS console or an DADM. Use the DSS to transfer the call, even though the DSS LED associated with the station you are “transferring to” is red.

► To transfer call to a busy station

1. Press DSS corresponding to the busy station to be called.

You may hear a busy tone. The original caller is placed automatically on hold. The Line or extension LED flashes green at double the on-hold rate, and the DSS LED remains steady red.

2. Hang up.

The call rings the called station once with the camp-on tone. While the called station is receiving this tone, the Line LED flashes green (on-hold rate) or if you are on a extension button, it goes idle. The [DSS] LED remains steady red.

When the called station answers the transferred call, the Line LED becomes steady red. The [DSS] LED remains steady red.

Note If the busy station is in the Do Not Disturb mode, the call will not transfer, but will recall your telephone immediately.

If the call is not answered after a specified Recall time set in system programming, camp-on is cancelled and the transferred call rings back.

Call Answering (Outside Line)

If your DADM or DSS console is equipped with a Line button, you can answer outside line calls from the DADM or DSS console as you would from a digital telephone.

- To answer an incoming outside line call to a DADM or DSS Console, press the flashing Line.

Speed Dial

Your DADM or DSS console may be equipped with SD (Speed Dial) buttons that can be programmed to dial telephone numbers or to access features. SD buttons on either the DADM or DSS console function like SD buttons on digital telephones.

Paging

You can make an announcement page to a group of telephone speakers selected in system programming with All Call Page on the DSS console. SD (if programmed) on either the DSS console or the DADM can be used for page announcements. See [“All Call Page” on page 63](#).

Call Forward Override (DSS Override)

Either the DSS buttons on your DSS console or the associated telephone can be set in system programming to ring stations that are in the Call Forward mode, instead of being forwarded. Usually the console’s telephone is the unit activated to perform this function. Among other applications, this feature can be used to notify a person who forgets to deactivate the Call Forward feature after returning to the office.

► To override call forward with the console’s associated telephone

1. Press Cnf/Trn or extension button.
2. Dial the station number set for call forward.

Make the call as you would from any other station. This procedure assumes your station has a typical program setting.

► To override call forward with your DSS Console

- Press the station DSS button set for Call Forward.

Night Transfer Button

This button enables a pre-programmed station to place the system into Day, Day2 or Night Mode. See your System Administrator for information on the settings for Day, Day2 or Night Mode. Usually, these modes will transfer calls to a designated location or voice mailbox, depending on programming.

1. Press Night Transfer.
2. Press the desired Mode number:
 - Press 1 for Day Mode (LED remains off).
 - Press 2 for Day2 Mode (LED flashes red).
 - Press 3 for Night Mode (LED is solid red).

Your system may be equipped with the Centrex Application, which enhances its feature capability when installed behind a Centrex or PBX system. Your telephone may have access to one or more of the enhanced Centrex features listed below:

Flexible Directory Numbering

A station's extension can be three or four digits. It is, therefore, possible to match a station's extension and Centrex line extension number. Dial the entire station number when indicated.

Note Some access code numbers may have been changed to avoid system numbering plan conflicts.

Centrex Feature Buttons

You can access some Centrex features by pressing a pre-programmed Flexible Button on your telephone, instead of dialing a Centrex access code. The Centrex access code, including the necessary flash and/or pause sequence, is activated when the button is pressed. See your Centrex or PBX operations manual for specific details.

Ringling Repeat

The distinctive ring patterns available in your Centrex system are automatically repeated with your digital telephone, enabling you to answer appropriately for either outside, inside or callback calls.

Delayed Ringing

Outside line or Centrex line(s) can be programmed for a 12-second and/or 24-second ring delay at stations to permit alternate answering conditions. Answer the line when your telephone is ringing.

Button Labels

B

All Flexible Buttons must be programmed for your telephone in system programming and vary for individual telephones. If a button does not appear on your display or telephone keystrip label, see your System Administrator for button assignments.

The button labels in [Table 18](#) are for the Programmable Buttons on your telephone. Programmable buttons are the unmarked buttons on your keystrip.

Table 18 Feature Button Definitions

Button	Definitions
Account Code	Account Code – Press to enter a Voluntary Account Code anytime during a Central Office (outside) line call without interrupting the conversation.
All Call Page	All Call Voice Page – Press to page all of the telephones in the All Call Page group.
Auto Busy Redial	Automatic Busy Redial – Press to set up Automatic Busy Redial after receiving a busy tone on a dialed outside line call (not available when calling on Tie or Direct Inward Dialing (DID) outside lines).
Auto Callback	Automatic Callback – Press to recall a busy station or station in the Do Not Disturb (Do Not Disturb) mode as soon as that station becomes idle or deactivates Do Not Disturb. Also used for outside line queuing when all lines are busy.
Call Frwd All Calls	Call Forward-All Calls – Press to forward all calls to another station or voice mail device.
Call Frwd Busy	Call Forward-Busy – Press to forward calls immediately to another station or voice mail device when your station is busy or in the Do Not Disturb mode.
Call Frwd Busy NAns	Call Forward-Busy/No Answer – Press to forward calls immediately to another station or voice mail device when your station is busy or in Do Not Disturb mode. Also forwards calls when your station is not answered after 8-60 seconds (set at your station).

Button Labels

Delayed Ringing

Table 18 Feature Button Definitions *(continued)*

Button	Definitions
Call Frwd No Answer	Call Forward-No Answer – Press to forward calls to another station or voice mail device when your station is not answered after 8–60 seconds (set at your station).
Call Frwd External	Call Forward-External – Press to forward Private or DID line calls to an external or internal telephone number.
Caller ID	Caller ID – Press to view the Call History list (may include name/number, date, status).
Directed Pickup	Call Pickup – Press to initiate a ringing Directed Call Pickup of outside line, extension, and page calls.
Do Not Disturb	Do Not Disturb – Press to lock your station in or out of the Do not Disturb mode.
DSS	Direct Station Selection(s) – Press to ring a preselected station. The LED associated with each DSS button provides the status (idle/busy) of the station assigned to the button.
Flash	Flash – Press to perform the following functions: Disconnect and recall dial tone on a outside line; access Centrex or PBX features; enter a pause or flash signal when programming speed dial numbers.
Group Pickup	Group Pickup – Press to pick up a call that is ringing a station that belongs to a Pickup Group that your station is a member of.
Line	Line – Press to answer or access an outside line.
Microphn Cut-off	Microphone Cutoff – Press to turn the microphone off/on while idle, providing privacy when you receive handsfree internal calls. Also functional when your station receives calls – The Mic button controls the microphone when you originate calls.
Msg Wait	Additional Messages Waiting
Night Transfer	Press to control the system's outside line ringing pattern for after-hours incoming calls.
Park in Orbit	Park – Press to park internal or outside calls in an orbit. Call retrieval can be made locally from the same parking telephone or remotely from a different telephone.
Pooled Line Grp	Pooled Line – Press to access an available outside line from a group of lines appearing under one button.
Privacy on Line	Privacy – Press to block Privacy Override on common outside line buttons. This button does not block Busy Override or Executive Override.

Table 18 Feature Button Definitions *(continued)*

Button	Definitions
Privacy Release	Privacy Release – Press to release privacy on common outside line buttons, enabling other station users to enter your conversations on those buttons. Privacy release does not apply to common extension buttons which are always private.
Program	Program – Press to enter User Programming mode, which enables you to re-define Flexible Buttons to perform other functions, including programming One Touch and Flexible Buttons, register Call Forward assignments, assign Message Waiting Keys and assign BGM sources played over the telephone speaker.
PS/RES	Pause/Resume – Press to pause or resume recording a conversation to a voice mailbox or when playing back the recording.
Record	Record to Voice Mail – Press to record current conversation to voice mailbox.
Release and Ans	Release and Answer – Press to disconnect or complete the transfer the current outside or extension call and automatically answer the new incoming outside or extension call.
Release Call	Release – Press to disconnect or complete the transfer of the current outside or extension call and to place your station in the idle condition.
SD or Customized Button	Speed Dial – Press to Speed Dial a telephone number or feature access codes. SD buttons can be used as either System Speed Dial numbers or Station Speed Dial numbers.
Spd Dial Lng Pause	Pause (Long) – Press to insert a 10-second pause when programming Speed Dial numbers.
Spd Dial Pause	Pause – Press to set either a one-half or two-second pause when programming Speed Dial numbers. (The pause time is set in system programming).
Start	Start – Press to make an outgoing call using an ISDN trunk.
Sub	Sub address – Press to enter a sub address on an ISDN trunk outgoing call.
Tel Set Music	Background Music – Press to turn Background Music on or off over your station speaker.
Tone Dial Select	Tone – Press to change the outgoing dialing of the outside line in use from dial pulse to tone signaling.
Unlock Door	Door Unlock – Press to unlock a door lock mechanism.

This page is intentionally left blank.

Index

A

abandoned call numbers (see Call History), 47
about this book
 conventions, xi
 how to use this guide, xi
 organization, ix
 related documents, xii
access codes, 65, 66, 129, 132
account codes, 35, 129, 132
 calls, 35
 forced, 35
 verified/non-verified, 35
ACO
 911 emergency service, 81
 hold, 84
 LED and LCD Indication, 83
 limitations, 85
 volume control, 82
add-on module/DSS console, 137
advisory messaging, 134
alarm clock, 120
all call page, 63
alphanumeric entry, 98, 117
ANI, 47
answer a call, 17
answering calls, 15
attendant console, 132
automatic

 busy redial, 129, 132
 callback, 38
 callback cancel, 129, 132
 hold, 26
 line selection, 14
automatic hold, 26

B

background music (BGM), 39, 129, 132
busy override, 60
button
 labels, 145
 programming, 129
buttons
 3200-series LCD, 5, 11
 DSS on ADMs and DSS consoles, 139
 extension, xi
 fixed, 3, 10
 flexible, 4, 11
 one touch, 130

C

caller ID, 47
call forward
 access codes, 129
 any call, 41
 override, 142
 station, 40
 system, 40

- call history, 47
- call hold, 26
- calling, 15
- calling from SoftIPT, 28
- call monitor, 121
- call park, 132
 - orbits, 47
- call pickup, 49, 129, 132
 - held calls, 133
- call recording, 76
- call transfer, 20
- call waiting, 51, 61
- centrex
 - application, 143
 - feature buttons, 143
- class of service
 - override, 62
- CO line
 - call transfer, 20
- CO line buttons, 13
- CO line queuing, 52
- conference
 - calls, 22, 133
 - hold, 26
 - split/join/drop, 24
 - voice mail, 23

D

- DADM, 8, 138
- delayed ringing, 144
- dial directory, 16
- dial pad, 98, 117
- digital add-on module (DADM), 138
- direct inward system access (see DISA)
- directories, 98, 117
- direct station selection, 95, 114
 - buttons, 52
- DISA

- security code, 133
- distinctive ringing, 53
- DKT3200-series telephones, 1
- do not disturb, 54, 133
 - override, 60
- door lock, 55
 - control, 133
- door phone, 56
 - calling, 133
- drop, 24
- DSS, 52
 - buttons on ADMs and DSS
 - consoles, 139
 - call answering, 141
 - call forward override, 142
 - calling, 140
 - console, 137, 139
 - night transfer, 142
 - paging, 142
 - speed dial, 141
 - transferring, 140

E

- echo cancellation, 57
- emergency
 - call, 133
 - calling 911, 81
 - page, 63
- emergency call, 57
- emergency ringdown, 58
- exclusive hold, 26
- executive override, 61
- extension number, xi
- external directory, 96, 115

F

- feature access codes, 132
- FeatureFlex, 123

flash, 129, 133
flexible buttons, 4, 11
 codes, 129
flexible directory numbering, 143
forced account codes (verified/non-verified), 35

G

group line button, 13
group pickup, 49

H

handset calling, 15
handsfree answerback, 17
hold, 26
 line hold, 20, 48
hot dialing, 14, 15

I

IADM, 1
indicators
 LED, 136
internal directory, 96, 115
IPT1020-SD, 57
IPT2008-SDL
 alphanumeric dial pad, 100
 buttons, 92
 idle display, 93
 name storage, 67
IPT2010-SDC, 79
ISDN
 buttons, 68, 147

J

join, 24

L

language changes, 133
language code, 58
LCD
 (large screen), 113
 3200-series buttons, 5, 11
 contrast, 27
LCD control buttons, 5
LCR
 dialing out, 133
LED indicators, 136
line
 access, 13
 automatic selection, 14
 buttons, 13
 ringing preference, 14
line button, 13, 20

M

making a call, 15
message waiting, 18, 133
message waiting light
 on another telephone, 19
 on phantom ext/MW, 19
messaging
 advisory, 134
Mic button, 19
microphone, 82
microphone cut-off, 58, 59, 129
Msg button/LED, 18

N

names
 storing speed dial, 97, 116
names (entering), 98, 117
network access, 134
networked systems and stations, 77

night ring answer, 134
night transfer button, 142

O

off-hook call announce (OCA), 59, 134
one touch button, 130, 131
outside line access, 13
override
 access codes, 134
 busy, 60
 call forward (DSS), 142
 class of service, 62
 do not disturb, 60
 executive, 61
 privacy, 62
 travelling class, 135
override calls, 60

P

paging, 49, 142
 access codes, 129, 134
park, 132
 park in orbit, 48
park in orbit, 48
personal speed dial, 66, 96, 115
pickup, 49
pick up group calls, 49
pooled line group, 13
privacy, 64
 override, 62
private network access, 134
programming
 buttons, 129

R

redial, 20
repeat last number dialed, 134

return call, 122
ringing
 distinctive settings, 53
 line preference, 14
ringing line preference, 17
ringing repeat, 143

S

screen call, 123
signaling
 tone, 14
 voice first, 14
SoftIPT
 buttons
 more features, 30
 setting, 30
 calling, 28
 directory, 29
 label feature buttons (Line1~Line6), 30
soft keys, 5, 32, 33
 2000-phone location, 11
 3200-phone location, 5
 DKT3014 LCD, 66, 95, 96, 114, 115
 left and right tab, 94
 Stratagy voice mail, 71
speakerphone, 17
special characters for speed dialing, 67
speed dial, 65, 130
 access codes, 65, 66, 129, 135
 names, 97, 116
 personal, 66, 96, 115, 131
 system, 66, 96, 115
speed dial (DADM or DSS), 141
Spkr button, 15
 answering, 17
split, 24
start application, 135
storing speed dial names, 97, 116

system speed dial, [66](#), [96](#), [115](#)

T

tabs, [94](#)

tone/pulse dialing, [68](#)

tone signaling, [14](#)

transfer, [20](#)

travelling class override, [135](#)

two (tandem) CO line connection, [23](#)

U

uniform call distribution (UCD), [69](#)

user programming, [127](#), [129](#), [135](#)

V

voice first signaling, [14](#)

voice mail

- access codes, [135](#)

- call record, [76](#)

- conference, [23](#)

- direct transfer, [71](#)

volume control, [135](#), [136](#)

voluntary account codes (verified/non-verified), [36](#)

W

Web

- accessing the web, [99](#)

- alphanumeric dial pad, [100](#)

- application Icons, [100](#)